

MarSurf

Mahr

Mahr

MarSurf CM expert

OPTICAL

3D MICROSCOPY

.....|.....|.....|.....|.....|.....|.....|.....|

OPTICAL 3D SURFACE METROLOGY FOR INDUSTRY AND RESEARCH

- Proven technology
- High precision with 16-bit HDR-technology

This what we mean by **EXACTLY**.

- 0 +

Mahr

EXACTLY

OPTICAL 3D SURFACE METROLOGY FOR INDUSTRY AND RESEARCH

RESEARCH & DEVELOPMENT



PROCESS CONTROL



PRODUCTION CONTROL

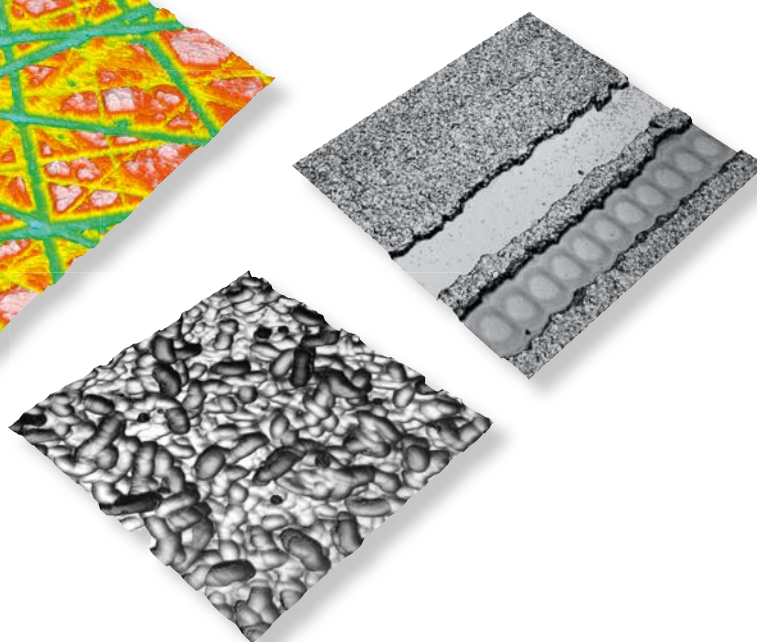
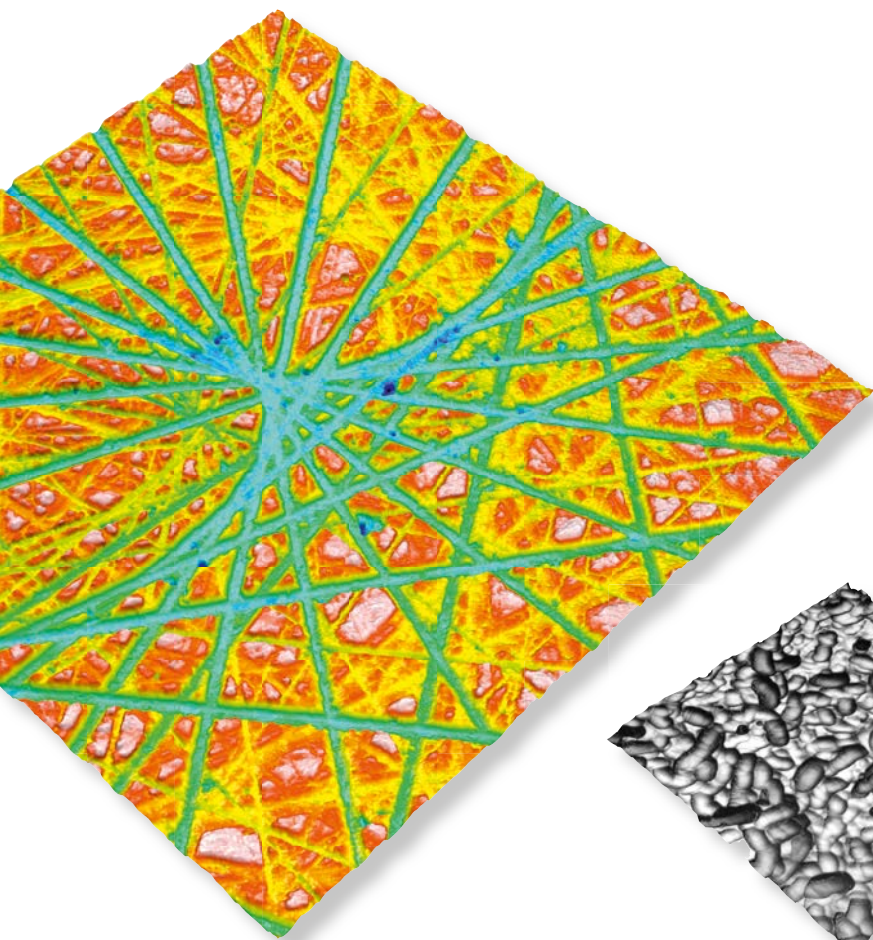

MarSurf CM - OPTICAL 3D MICROSCOPY

ONE TECHNOLOGY - MANY BENEFITS

- 1 Maximum performance**
Combination of high measurement point density and measurements within seconds
- 2 High precision with 16-bit HDR technology**
Modern imaging sensors, high-performance optics and linear encoders for standard-compliant measurements
- 3 Real 3D measurement data**
Physical data acquisition with patented confocal multi-pinhole technology
- 4 Intuitive operation**
Well-thought-out operating concept and ergonomic workplace solutions
- 5 Easy automation**
User-independent serial measurements compliant with industry requirements
- 6 Robust construction**
High level of repeatability due to practically conceived industrial design
- 7 High level of flexibility**
Modular hardware component design, powerful software solutions and standardized interfaces



MarSurf CM - OPTICAL 3D MICROSCOPY

QUALITY AND STANDARD COMPLIANCE

- The innovative confocal technology delivers high resolution 3D measurements of surfaces. It thus enables new insights into surface structures and treatment processes.
- The confocal principle used in the surface measurement allows the data to be presented as true height coordinates (x, y, z). A precise evaluation is only possible with this quantitative information.
- Numerous ISO-compliant profile and surface parameters ensure the comparability and usability of the results, both in R&D and in production.
- Mahr always implements the latest standards in measuring systems and software.

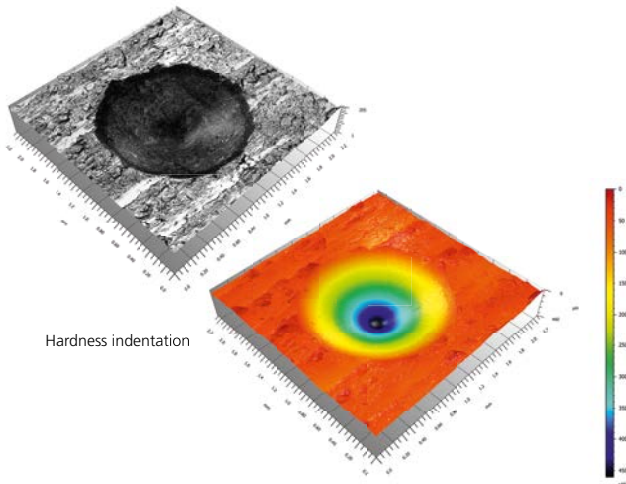

SPEED AND FLEXIBILITY

- The fast image acquisition of the MarSurf CM systems delivers high resolution 3D data sets in only a few seconds.
- Additionally, the sample preparation required by other technologies can be dispensed with (e.g. anti-reflective coatings or sputtering).
- The intuitive user guidance of the measurement software ensures a straightforward and quick start to the measurement process.
- Measurement data is placed into a complete measurement report without time-consuming intermediate steps.
- The measuring devices can be used both in the laboratory and in production environments.
- Measurements are possible on virtually any material combination.

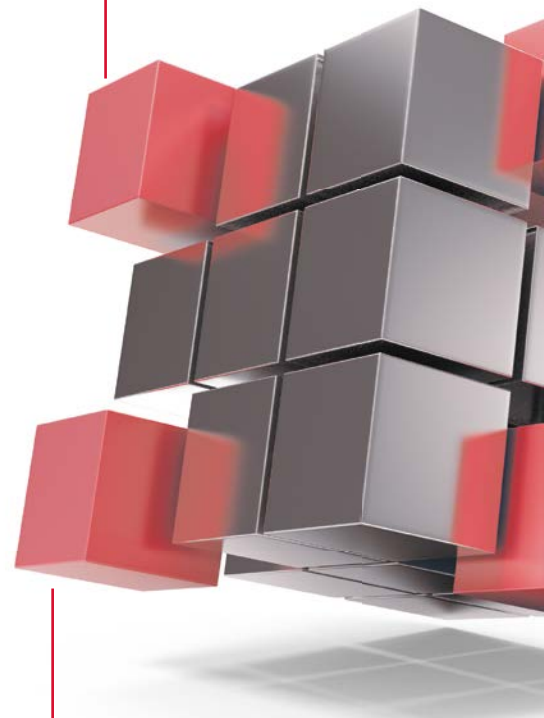

REPRODUCIBILITY

- The physical data acquisition results in reproducible and accurately repeatable measurements.
- The stable mechanical construction of the MarSurf CM Series optimizes the quality and stability of the measuring data
- Each axis can also be equipped with a high-precision linear encoder.
- The commissioning of all systems is based on calibration with certified standards. A signed acceptance protocol including calibration certificates is provided.
- The automation option ensures the maximum reproducibility of the measurement results.



AUTOMATION

- The measuring process and data evaluation can be fully automated.
- Thanks to fiducial recognition, possible errors in sample positioning can be detected automatically and corrected without user input.
- Integrated measurement range tracking makes industrial-grade, fully automated measurement possible.
- Industrial requirements for complete automation are met via functions such as user management, database connections, data matrix code reading, tolerance checks, and SPC charts.

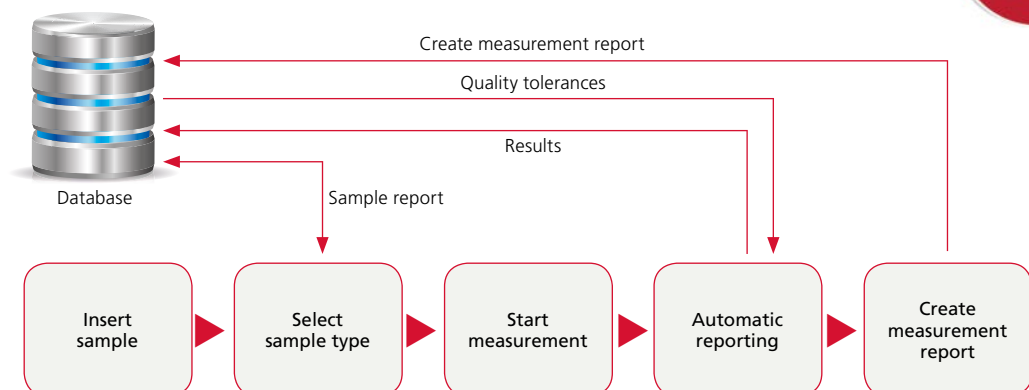

MarSurf CM - OPTICAL 3D MICROSCOPY

APPLICATIONS

Volume

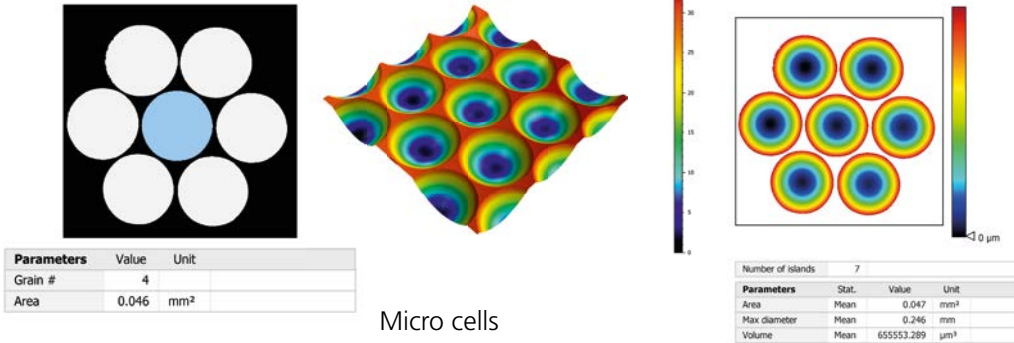

Form, contour

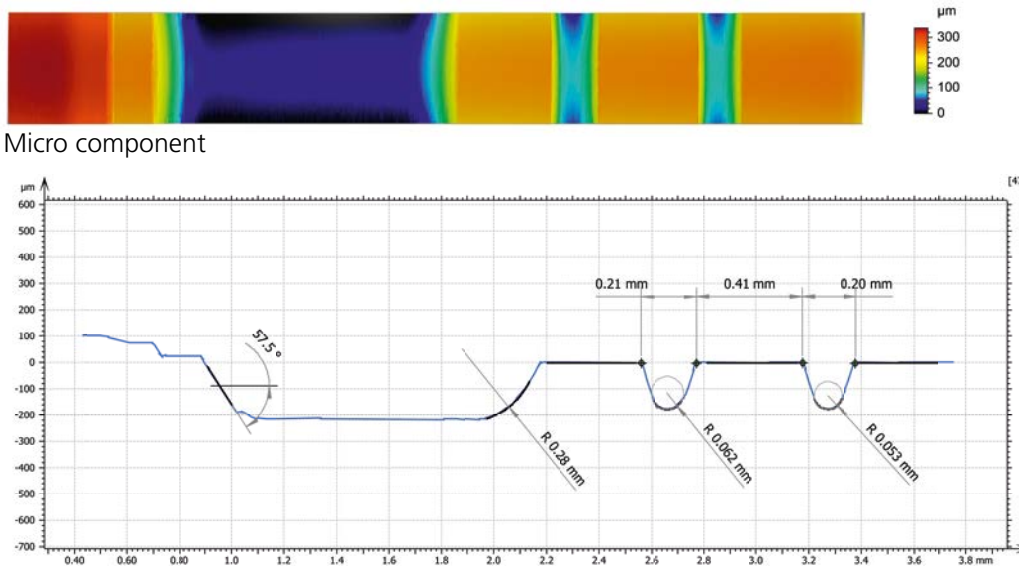

Flatness, coplanarity

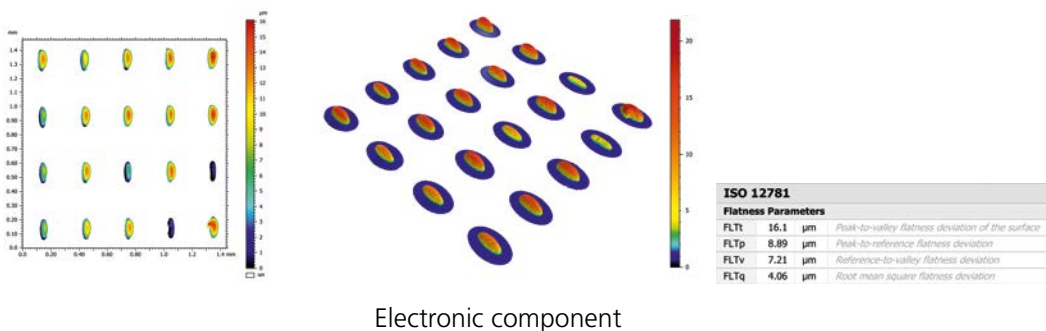



Tribology, bearing surfaces, functional volume

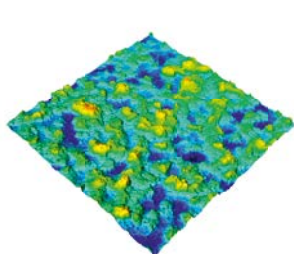

Sanding belt new

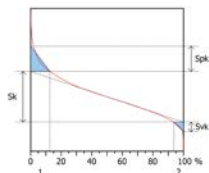
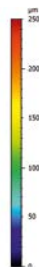

Parameters	Value	Unit
Sk	72.3	μm
Spk	36.1	μm
Svk	13.6	μm
Sr1	12.6	%
Sr2	93.6	%

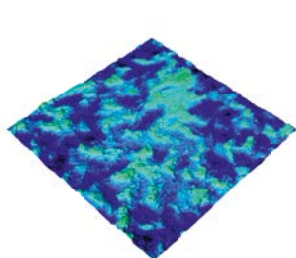
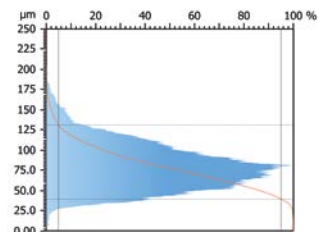

Sanding belt used

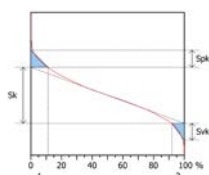
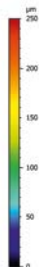

Parameters	Value	Unit
Sk	43.3	μm
Spk	13.2	μm
Svk	13.1	μm
Sr1	11.2	%
Sr2	91.8	%

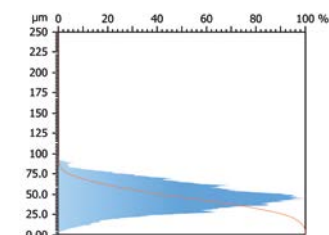

2D and 3D surface finish according to international standards

	Context	Mean	Std dev
ISO 4287			
Amplitude parameters - Roughness profile			
Ra	μm	1.594	0.002
Rq	μm	1.928	0.003
Rz	μm	7.844	0.032
Rt	μm	9.454	0.213

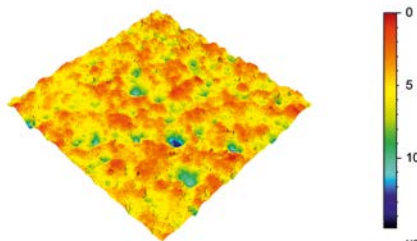

Structured sheet metal

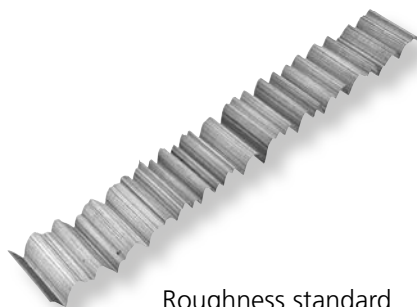

Roughness standard

ISO 25178			
Height Parameters			
Sa	1.17	μm	Arithmetic mean height
Sq	1.56	μm	Root mean square height
Sp	4.53	μm	Maximum peak height
Sv	10.3	μm	Maximum pit height
Sz	14.8	μm	Maximum height
Feature Parameters			
S10z	10.2	μm	Ten point height

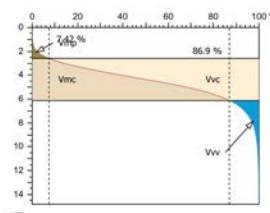
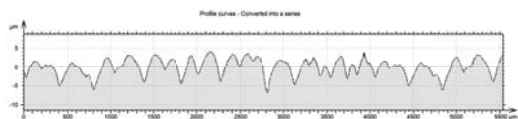

MarSurf CM - OPTICAL 3D MICROSCOPY

INDUSTRIES

Automotive

- Power-train
- Body-in-white
- Interior
- Electronics
- Glass components
- Coatings

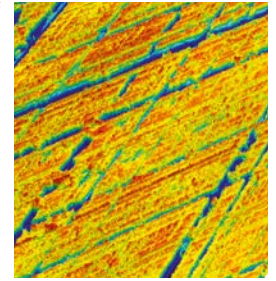

Energy

- Solar cells
- Fuel cells
- Batteries
- Gearbox and turbines

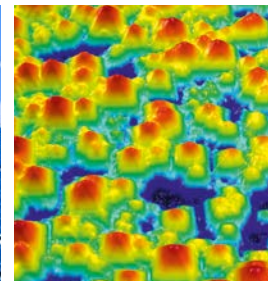

Printing and security

- Printing cylinder
- Printing plates
- Paper sieves
- Bank notes
- Security features
- Works of art
- Chip cards

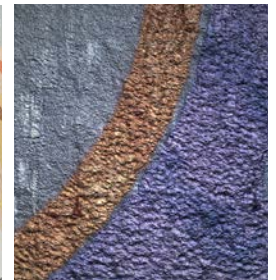

Electronics & semiconductor

- BGA
- MEMS
- High performance electronics
- Microelectronics
- Microvias
- Hybrid technology
- Conductor tracks and plates

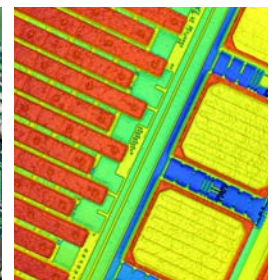

Medical technology

- Implants
- Microfluidics
- Sensors
- Stents
- Microtomes
- Smart materials

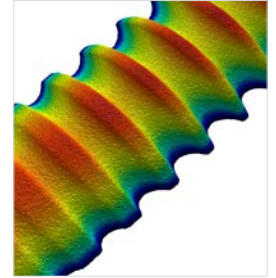
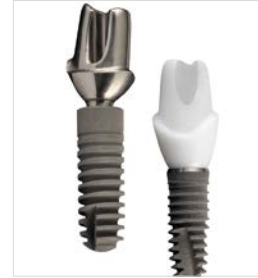

Microsystems

- MEMS
- LED
- High performance electronics
- BGA
- Micro-optics

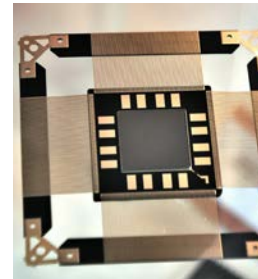

Tools

- Cutting and milling tools
- Razor blades
- Sand paper
- Coatings
- Micro-tools



Materials science

- Surface processing
- Lightweight construction
- New materials
- Laminates
- Ceramic
- Fibers



MarSurf CM CONFOCAL TECHNOLOGY

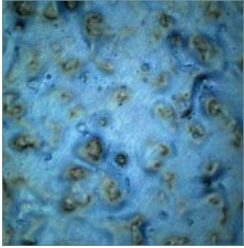

Microscope image focused and defocused points are mapped.

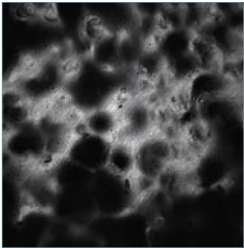

Confocal image only focused points are mapped.

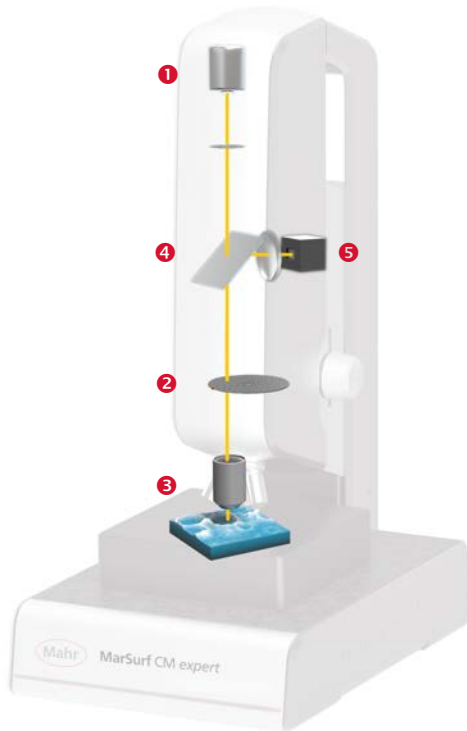

The robust MarSurf CM sensors are based on the patented CMP technology (confocal multi-pin-hole).

The light from an LED source (1) is focused through the pinholes on a multi-pin-hole-disc, MPD (2), and the objective lens onto a sample surface (3). The light beams are reflected back into the measuring system by the surface. At each pinhole on the MPD, the reflected light is reduced to the portion which is in focus. The light beams are deflected by a beam splitter (4) and captured by a camera (5).

Due to the rotation of the multi-pin-hole-disc, the surface is scanned seamlessly.

This principle prevents scattered light from neighboring measurement points from interfering with the camera pixels.

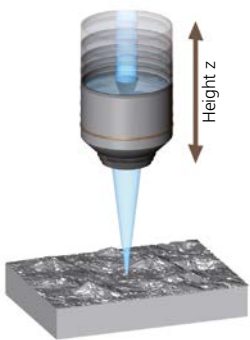

The objective lens is moved vertically via a z-positioning unit which allows images to be acquired at different heights. This results in an image stack.

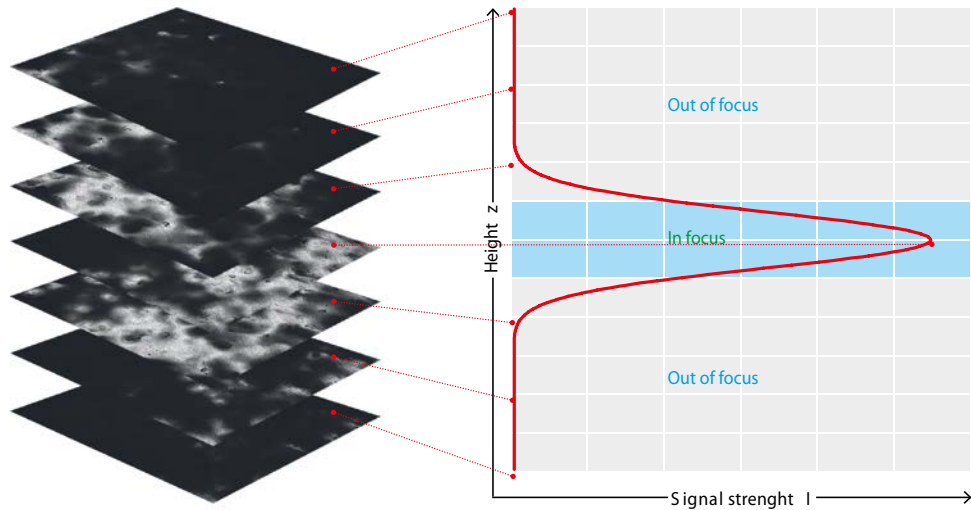

Each confocal image corresponds with a horizontal cross-section of the sample. More than 1,000 confocal images per measurement are acquired.

The light intensity for each individual pixel varies across all height levels. At maximum intensity, the measurement point is in focus. Observed collectively, the individual values result in the confocal curve. The precise height values of a pixel are then calculated based on the confocal curve.

Maximum signal quality using the patented multi-pinhole-disc

The multi-pinhole-disc was developed and patented by NanoFocus. The unique technology allows for ultra-fast image acquisition. In addition, it features an extremely low scattered light level and robust signaling at a high light yield. Thus, height resolutions in the nanometer range can be achieved. The stochastic distribution of the pinholes on the multi-pinhole-disc prevents two neighboring measurement points from being measured in direct sequence. In contrast to conventional linear scanning measuring processes, scattered light effects, measurement artifacts and preferential directions are prevented.

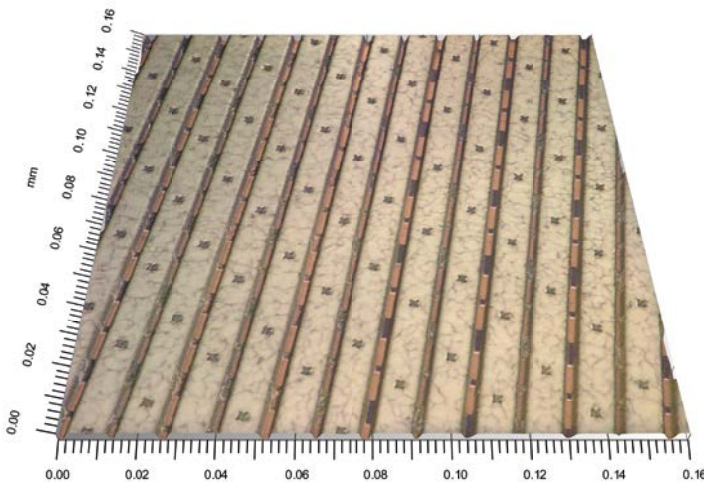
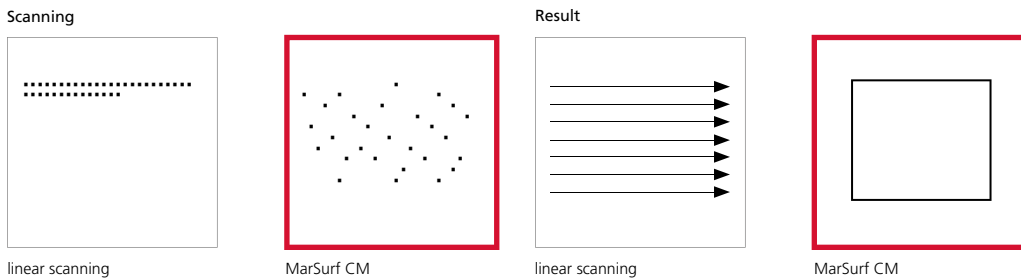
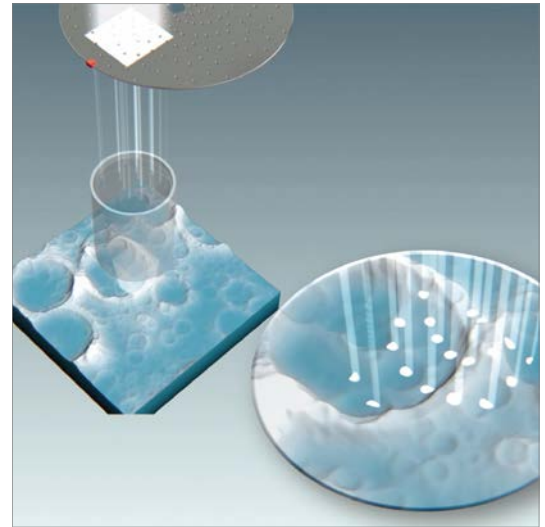

3D true color image

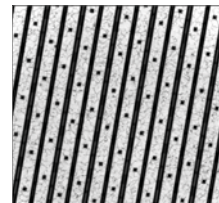

Intensity image

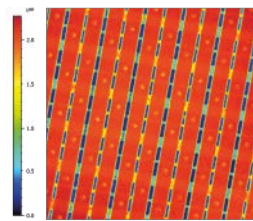

Topography image

The measured height values for each individual pixel result in a precise three-dimensional reconstruction of the surface. Due to the intensity information, a high-resolu-

tion, deep-focused microscopic image is provided simultaneously. If an optional color camera is used, a color image of the surface can also be generated.

MarSurf CM CONFOCAL TECHNOLOGY

IMAGE ACQUISITION MODULE

HDR function / 16-bit

The HDR function (High Dynamic Range) ensures an optimized visual representation of the measured surface. Height information can be captured in 65536 grayscales (16 bit). This means that over- and underexposure is minimized and finest contrast gradation can be detected. Surface structures with steep flanks and complex geometries can be measured with highest precision and free of artifacts.

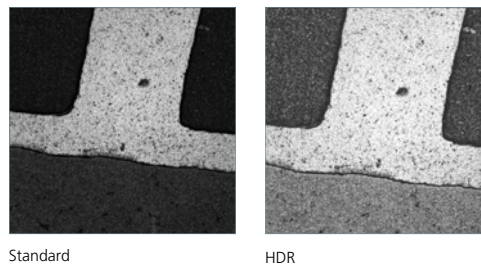

Binning

In binning mode, neighboring pixels are grouped in a pixel block. The signal-to-noise ratio is improved and the image acquisition is accelerated. Depending on the measuring task, the optimal ratio between resolution and image rate can be selected.

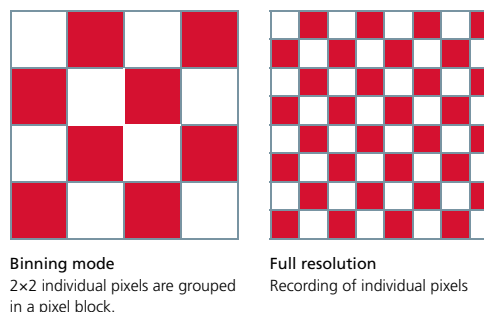

COATING THICKNESS MEASUREMENT

When measuring transparent samples, the intensity peaks of the reflecting light of the individual layers are recorded. If the focus level is set to an individual layer, the respective layer surface can be measured. The coating thickness can also be determined in this manner.

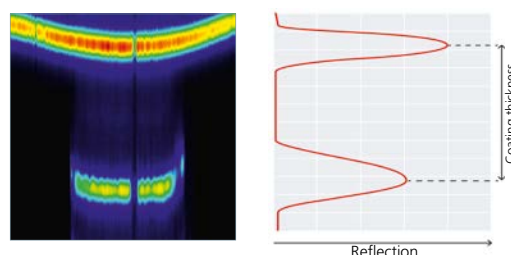
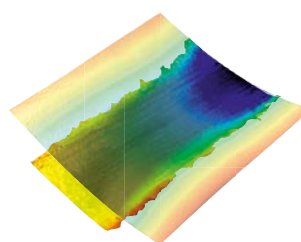

MarSurf CM CONFOCAL TECHNOLOGY

HD STITCHING

Using the HD stitching function (automatic image compilation), numerous images can be combined at full resolution to create an extensive, overall image. The image field can be selected flexibly. The stitching measurement is fully automated by motorized x,y,z axes.

Glass scales in all axes

Integrated glass scales ensure a high level of positioning accuracy and thus an artifact-free compilation of the images.

Fast stitching with high measurement point density

In contrast to other measuring methods, the measurement point density in the MarSurf CM technology stitching mode is not reduced during stitching / acquisition of larger FOVs. Despite this consistently high measurement point density, the measurement duration is significantly lower than in conventional technologies. This benefit is particularly apparent when stitching larger measurement ranges.

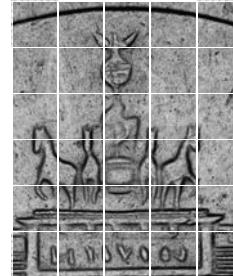

MarSurf CM 5x6 Stitching

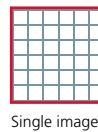

Single image

MarSurf CM 3x3 HD-Stitching

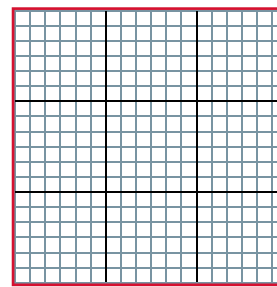

conventional 3x3 stitching

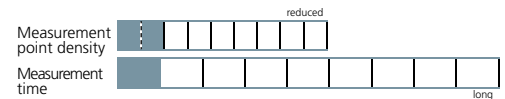
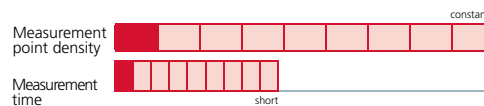
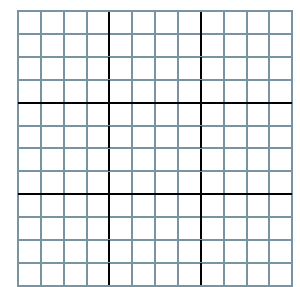

SHAPE TRACING

Automatic measurement range tracking

Shape Tracing offers the option of measuring concave, convex and wavy surfaces using the stitching process without previously setting the measurement range.

After a one-time automatic pre-scan, the surface tracking is executed without double scanning during the individual measurement. The measurement time is reduced by up to 7 times due to intelligent Shape Tracing.

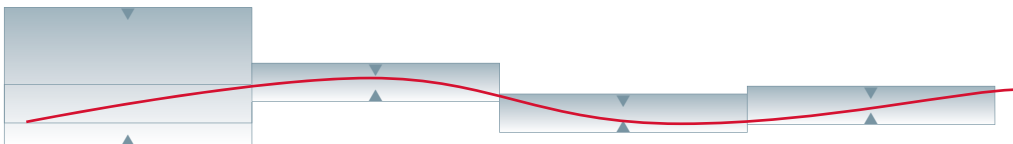

MarSurf CM: intelligent Shape Tracing with the highest measurement speed

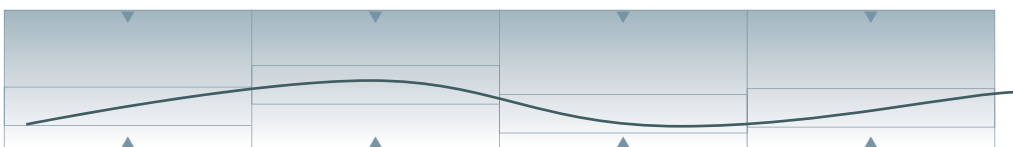

Conventional system: fixed measurement range and time-consuming double scanning

MarSurf CM CONFOCAL TECHNOLOGY

TECHNOLOGICAL BENEFITS

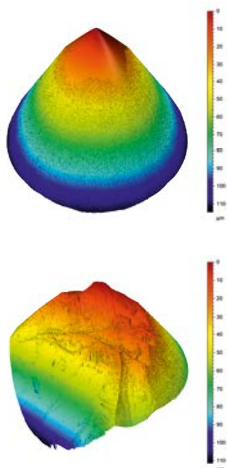

3D measurement of a new probe tip and a heavily used probe tip.

Compliance with standards and correlation with tactile data

The accurate profile representation of the finest roughness structures is a central quality criterion for the confocal measuring technology used by Mahr. In industrial applications, comparability with standard-compliant, tactile roughness measurement values in particular are extremely important. Numerous scientific and industrial studies clearly prove that Mahr systems fulfill the highest standards and can be used alongside tactile systems without conflicts. Mahr instruments are calibrated based on certified standards typically used in tactile roughness measuring technology. Profile and surface data is also evaluated in compliance with international standards such as the international ISO standard 25178.

Correlation between stylus profilometry and MarSurf CM confocal microscopy

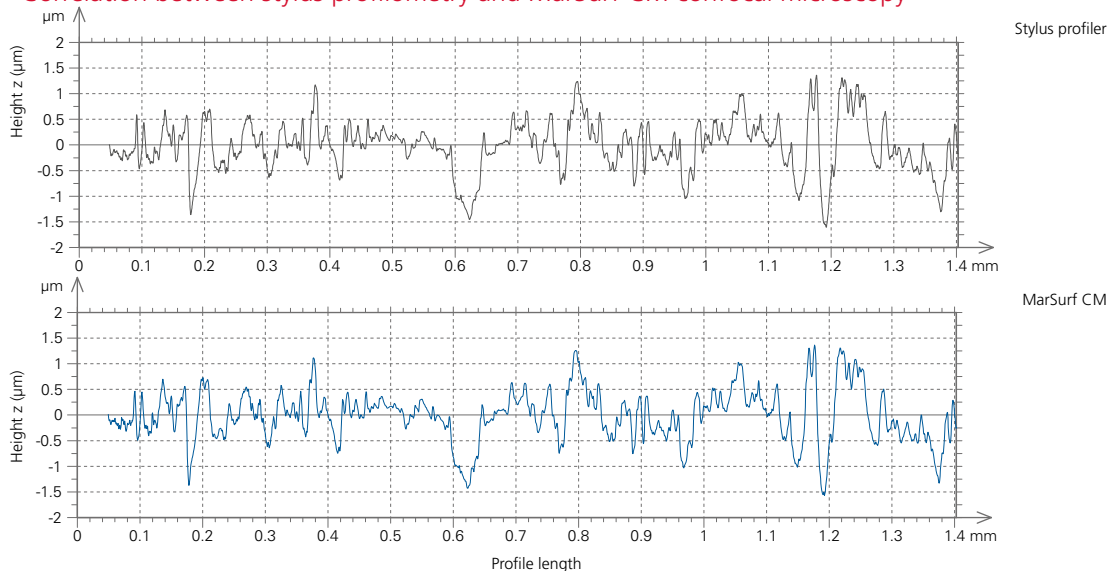

99% correlation (CCF)

within a representative comparative study: Correlations of topography measurements of NIST SRM 2460 standard bullets by four techniques, Meas. Sci. Technol., London, 2006

The ideal alternative to SEM and AFM

The confocal-optical technology offers many benefits for characterizing technical surfaces in the micrometer and nanometer range.

In contrast to scanning electron microscopy (SEM), with confocal surface measurement, the data is available as measured height coordinates (x,y,z). Only with this quantitative information it is possible to achieve exact evaluations of 3D parameters which make it possible to obtain much more meaningful results.

In addition, no sample preparation is required. In comparison to an AFM, an optical system offers several benefits such as a large measurement range, high speed and non-contact operation. The higher lateral site resolution of the SEM and AFM in comparison to optical systems is often not required in practice.

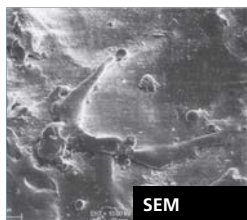

SEM

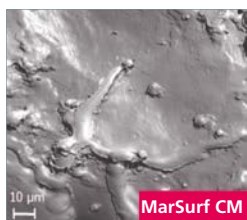

MarSurf CM

MarSurf CM CONFOCAL TECHNOLOGY

BENEFITS COMPARED TO OTHER OPTICAL MEASUREMENT METHODS

1

High resolution and great robustness

2

Ultra-fast measurements with a high measurement point density

3

High-quality and unfiltered raw data

4

Low level of scattered light thanks to patented multi-pinhole-disc

5

Reliable measurements of all surfaces regardless of surface properties

6

Excellent signal to noise ratio on steep flanks and high contrast features

7

Safety due to collision detection in all directions to protect your workpiece and measuring system

8

Fast overall measuring process without prior sample preparation or tilt correction

9

Robust hardware with low maintenance needs and minimum down-time

10

Highly-advanced technology made in Germany

POWERFUL SOFTWARE SOLUTION



INTUITIVE MEASUREMENT

- Well-thought out user interface
- Pre-scan function (navigator)
- Start of measurement in only a few clicks (snapshot technology)
- Automatic brightness adjustment (auto intensity)
- Automatic measurement range setting (auto range)
- Save all parameters as a template (template function)

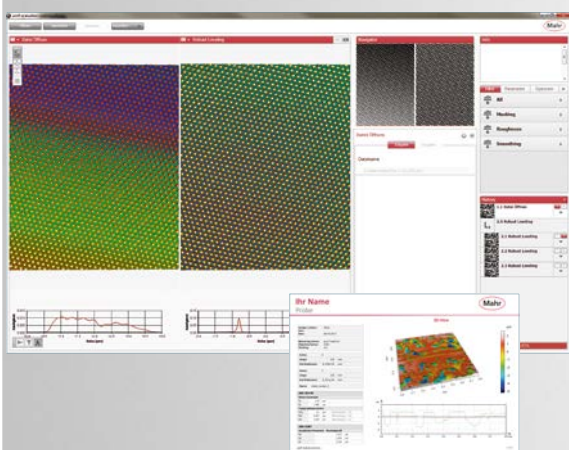

EFFECTIVE ANALYSIS AND DOCUMENTATION

- User-independent
- Powerful automation options
- Customer-specific adaptation and analysis
- 3D analysis, ISO 25178, ISO 13565, ISO 12781,...
- 2D analysis ISO 4287
- Geometry, volumes, contour, CAD comparison, ...



DETAILED RESULT DISPLAY

- 3D presentation, fast and high-quality display
- 3D measurement data overlaid with intensity and color measurement data
- Profile display
- Display of the results

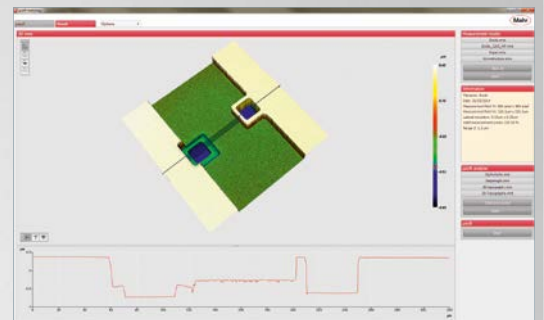

CUSTOMIZED AUTOMATION

- User-independent serial measurements
- Time-efficient operation
- Different measuring tasks and analyses in one measurement recipe
- Protocol generation and SPC control
- Database-supported



POWERFUL SOFTWARE SOLUTION

MarSurf MSW



Navigator-Funktion

The intuitive MarSurf Metrology measurement and control software (MarSurf MSW) guarantees the efficient performance of measurements.

With MarSurf Metrology, all sensors and an overview camera can be conveniently controlled from a single user interface. When switching between the sensors or the overview camera, the measurement head automatically moves to the defined measurement position. Powerful 3D displays of measurement results with intensity overlays are available after just a few seconds. The software is available in numerous languages.

Navigator function

With the Navigator function, a rapid overview can be created in which the desired measurement range can easily be selected with the mouse.

Template function

With the template function, measurement parameters can be stored as a template. Semi-automated measurement series can be implemented easily with this feature.

Snapshot technology

Thanks to the snapshot technology, the measurement process can be started immediately. The MarSurf metrology automatically controls all settings such as the focus area and brightness. At the same time, the software always allows individual settings by the user.

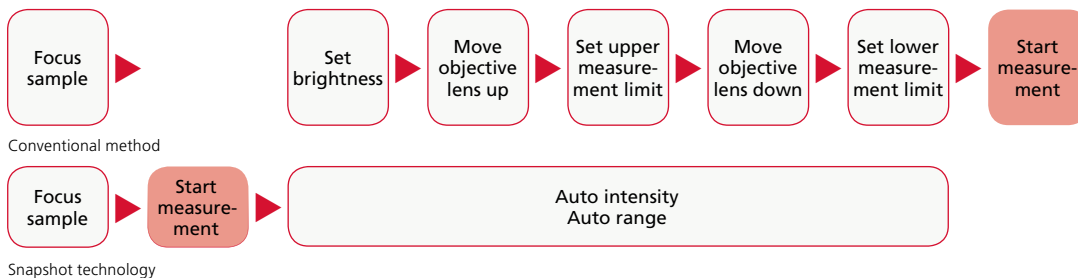

MarSurf MfM

The MarSurf MfM offers everything needed to present and analyze structure, roughness, waviness, level heights, contours and other surface characteristics. Complex analysis reports can be created at the push of a button in the intuitive, multi-language user interface.

Diverse presentation options such as the profile view, 3D reconstruction or reflection image generate detailed measurement protocols. The software always contains filter functions and the latest standard parameters according to ISO 25178, ISO 4287, ISO 13565 or EN 15178.

The software is available as a standard, extended and premium version. Further special modules, for example statistical evaluation, are available.

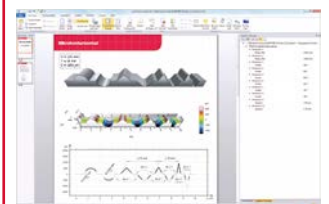

MarSurf ASW

With MarSurf ASW, it's easy to automate custom measurements and special analyses.

Customizable measurement recipes

An unlimited number of measurement recipes can be defined and stored in a database. The defined measurement parameters are stored in the measurement template and are available for later use.

An unlimited number of measurement positions can be defined on each individual sample. Custom sensor settings can be specified for each of these measurement positions. For series measurements, several samples are moved to and measured just as with single measurements. In this case, all the samples can be measured identically in accordance with the defined measurement settings, or the settings can be individually activated or deactivated for each sample.

Database-supported

MarSurf ASW has a powerful reporting library. Measurement results and reports are permanently stored and are therefore available for statistical process control. The central, network-capable database and the recipes stored there can be accessed from multiple systems.

Industrial strength

With support for registration mark detection, and transmission of measured data to statistical software (such as QS-Stat), the software meets current industrial standards. Simultaneous data collection and reporting on two different computers is supported. A strict separation between operator and administrator modes guarantees the greatest possible ease of use and reliable results.

Multisensor

Measurement recipes can also be carried out by multiple sensors. Here, a defined automatic change between sensors can be defined.



AUTOMATION WITH MarSurf ASW

1 RIGHTS MANAGEMENT

- Hierarchical user management with password protection
- Secure management of calibration data
- Granting or rights for operator, process, and administration levels

2 COLLECTING SAMPLE INFORMATION

- Entry of order-related information: e.g. user ID, component type, lot number, date/time and more
- Manual input of information
- Digital entry using a barcode reader or data matrix code reader
- Automatic linking of measurement recipes to associated evaluation recipes

3 VERIFICATION OF SAMPLE POSITION

- Detection and verification of the sample's position. Correction using registration mark detection is optionally possible.
- Comparison of placement accuracy when inserting the sample
- Compensation for component/dimensional tolerances with corresponding correction of measurement positions
- Acceptance of the new position and adaptation of the measurement recipe if necessary

4 MEASUREMENT

- Start of individual measurements or series measurements

5 AUTOMATIC EVALUATION

- Transmission of measurement data to the analysis software
- Analysis based on predefined report recipes or user-defined templates

6 AUTOMATIC REPORTING

- Comprehensive presentation of measurement results using clear measurement reports
- Customizable, high quality measurement reports
- Export as MS Excel or PDF

7 EXPORT TO DATABASE

- Transmission of the measurement dataset and measurement report to a predefined database
- Export of measurement results as ASCII in QS-Stat format or using an Excel VBA script

User

Password

In industry, the worldwide trend is towards user-independent, automated quality assurance. With measurement systems and automation software from Mahr, user-independent series measurements and inline inspections can be carried out efficiently. This increases throughput and reduces downtime. Measuring equipment capability is guaranteed thanks to the high repeatability of measurements.

Lot number

Date

Time

or



Measurement recipe

Report

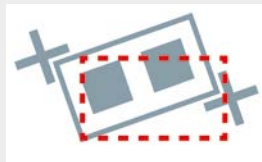

or



Reporting

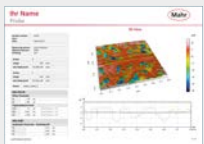

i.O./n.i.O.
SPC



MarSurf CM - OPTICAL 3D MICROSCOPY

CM PRODUCT LINE



MarSurf CM *explorer*



MarSurf CM *expert*



MarSurf CM *mobile*

MarSurf CM *select*

MarSurf CM explorer

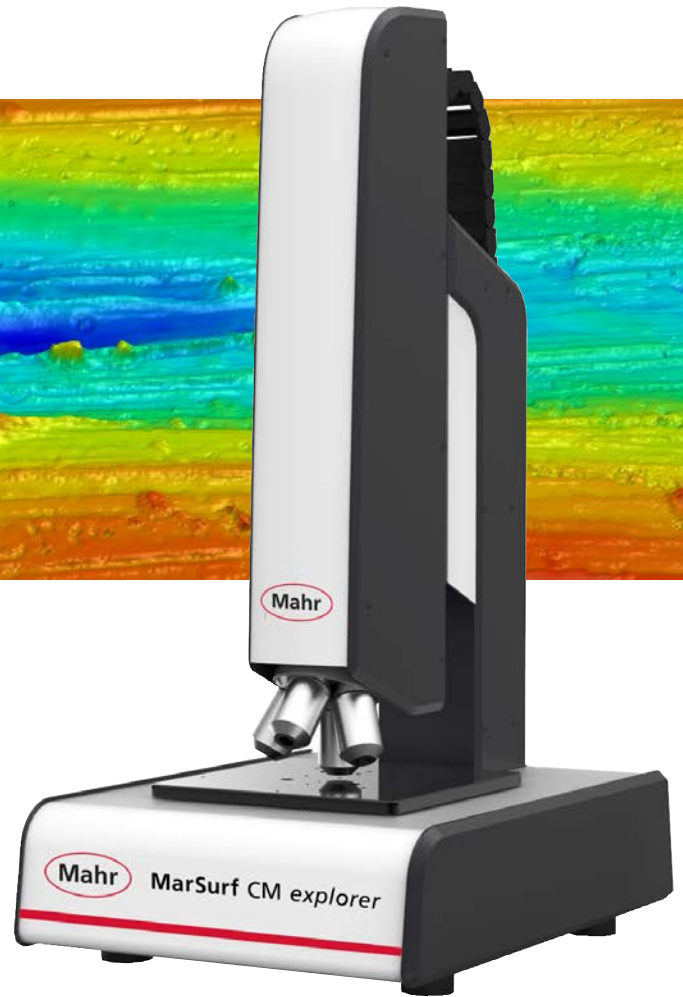
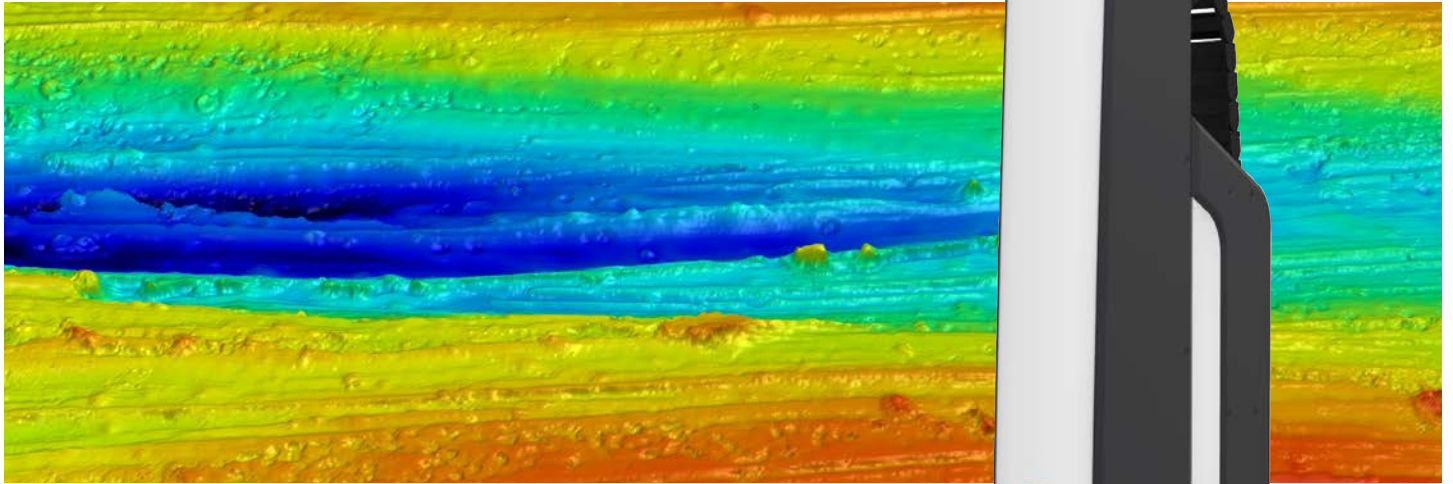

Flexible all-round measurement solution - the new generation

The compact and user-friendly MarSurf CM explorer is a complete package for precision measurement and analysis of surfaces.

The new generation of the MarSurf CM explorer combines proven qualities with the latest innovations of the MarSurf CM technology. The measuring system is fully equipped with HDR function, automatic lens detection and collision protection in all spatial directions.

The MarSurf CM explorer is suitable for economic use in laboratories and for quality assurance in production environments. It delivers reliable 3D measurement values quickly and easily in only a few functional steps.

➔ MarSurf CM explorer

- High measuring speed – even at full resolution
- User-friendly concept
- Safety through collision detection
- HDR function 16 bit
- HD stitching - Consistently high resolution even with large measurement areas

MarSurf CM expert

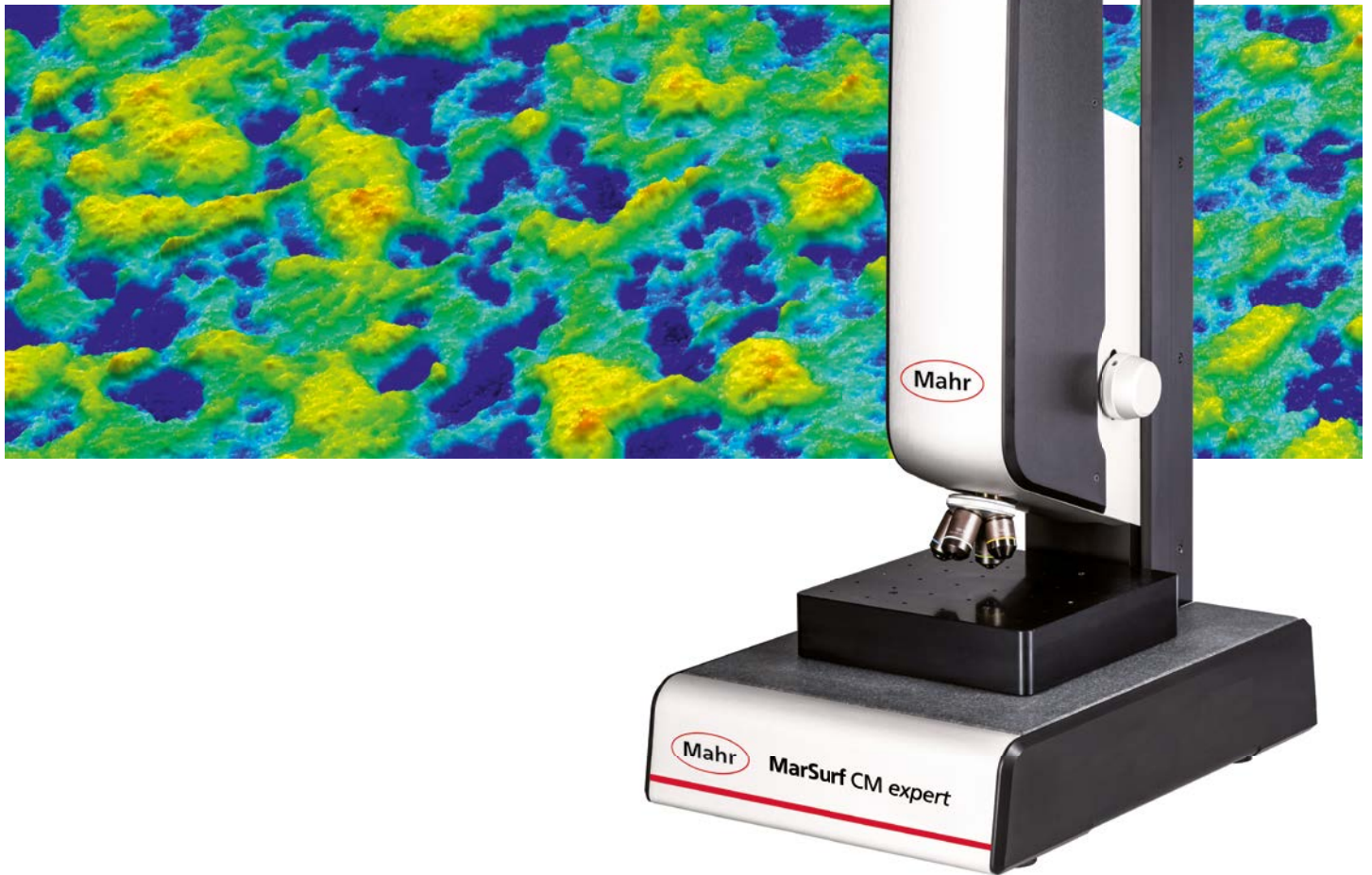

Powerful laboratory measurement system

MarSurf CM expert is optimized for use in testing and development laboratories and fulfills the highest requirements in the field of non-contact surface measurement technology.

The measuring system is equipped with high resolution sensors, linear encoders on all axes (x,y,z) and countless automation options. MarSurf CM expert offers the highest level of operating comfort due to manual z-axis positioning and an ergonomic design.

The option of having user-dependent and fully-automatic measurements is a feature of the measuring system for uncomplicated use for quality assurance.

➔ MarSurf CM expert

- High-end laboratory system for R&D and Quality Assurance
- Can be automated
- High measuring speed – even at full resolution
- User-friendly concept
- Safety through collision detection
- HDR function 16 bit
- HD stitching - Consistently high resolution even with large measurement areas

MarSurf CM *select*

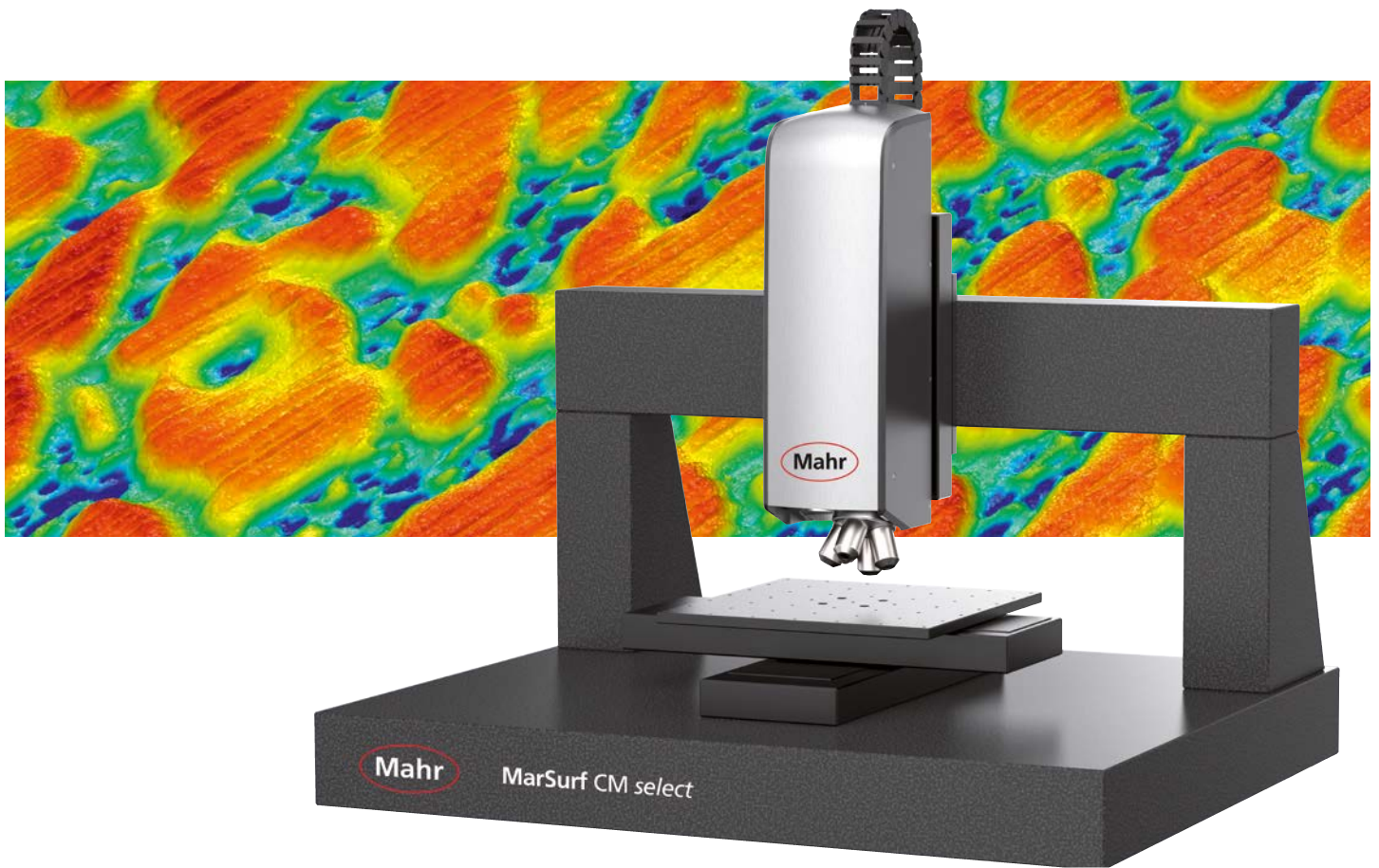

Tailor-made measurement system

Mahr adapts the MarSurf CM *select* precisely to suit customer-specific requirements. A large selection of hardware and software components is available. Thanks to its modular design, the measuring system can be adapted to different measurement tasks and individual requirements for automation, measuring convenience and accuracy. Thus, MarSurf CM *select* is the ideal solution for automated quality assurance, a wide range of uses in research laboratories and production environments.

As a multi-sensor system, MarSurf CM *select* offers the option of combining different sensor technologies in one measuring system. Depending on the measuring task, the optimal sensor can be flexibly selected. To en-

sure the highest level of user-friendliness, the standard sensors are controlled via one software.

➔ MarSurf CM *select*

- Customized configuration
- Can be automated
- Multi-sensors - wide range of additional sensors
- Large travel units
- Production-relevant interfaces
- Safety through collision detection
- Designed for continuous operation

MarSurf CM *select* + multisensors

Overview camera

Chromatic sensors (CP)

MarSurf CM *mobile*



Universally applicable

The new generation of the MarSurf CM mobile combines all its previously available unique features with the established HDR functionality of the stationary systems. The portable MarSurf CM *mobile* was developed in particular for measurements on large objects and samples that are difficult to move, e.g., rolls and vehicle bodies.

MarSurf CM *mobile* is ready to use on site in a few minutes. The measuring system only needs a laptop, without an additional controller, for operation. Since it only weighs 8 kg MarSurf CM *mobile* can be easily transported and used while travelling.

MarSurf CM *mobile* with a multi-objective is ideally suited for industrial application along the entire process chain. With an objective nosepiece and application-specific software solutions MarSurf CM *mobile* fulfills the requirements of a wide variety of measurement tasks.

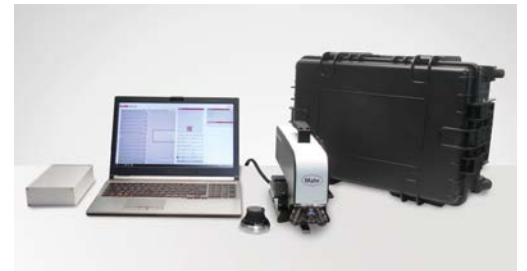

A customized case facilitates a simple transport of the system

➔ MarSurf CM *mobile*

- Mobile application - measurement directly on the component
- Compact system (8 kg) with motorized axes
- Robust and reliable for use in production
- High measuring speed – even at full resolution
- User-friendly concept
- HD stitching - Consistently high resolution even with large measurement areas

MarSurf - OPTICAL 3D PROFILOMETRY

FURTHER PRODUCT LINES

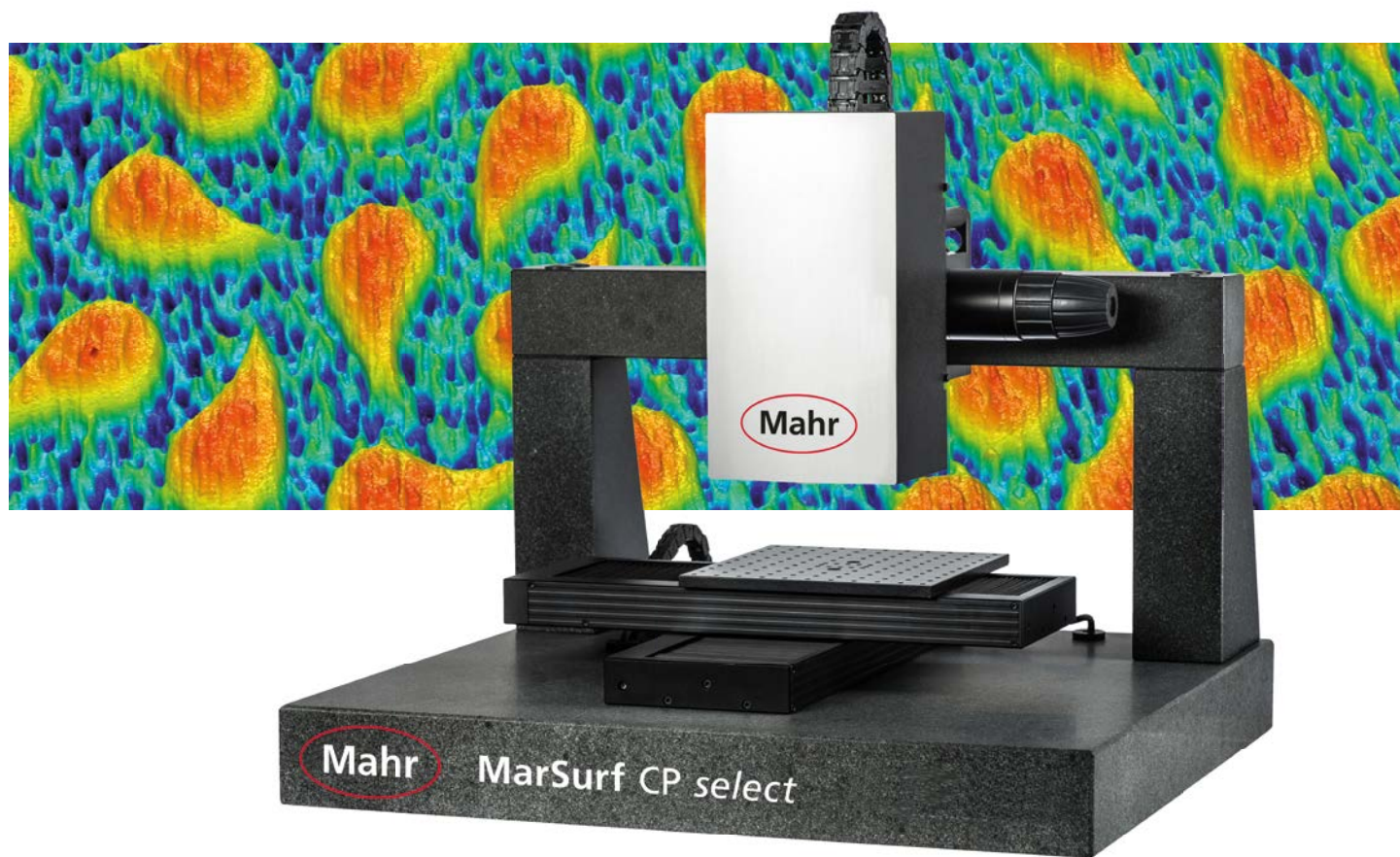

Flexible 3D Profilometers and Line-sensors for quality control

Using optical 3D technology, you can measure significantly faster than with conventional probe systems. That saves time and reduces costs.

Construction on granite and the use of first-class components guarantee high repeatability of measurements. The measurement of large and heavy samples is no problem. MarSurf CM *select* and MarSurf CL *select* can be fully automated and conveniently integrated into quality assurance processes using industrial-strength interfaces.

A modular design and capacity for connecting to different sensors allows the adaptation to many different measuring tasks. The manual z adjustment with fine tuning guarantees high operating comfort. Alternatively, a motorized z-axis is also available.

➔ MarSurf CP / CL *select*

- Point and line sensors
- High measurement speed
- Large area scan
- Large height measurement range
- Contact-free and non-destructive
- Can be automated



Brief Descriptions for Data Sheets of Optical Surface Measurement Devices

Version 1.2.1

	Term	Definition	
Device-specific features	General features	Positioning volume	Volume range in which measuring positions can be approached as well as the effectively usable path lengths of the axes
		Maximum number of measuring points in a single measurement	Maximum number of measuring points in a single measurement in X and Y as well as the total number of measuring points X·Y
		Maximum number of measuring points	Maximum total number of measuring points in a stitched measurement that the instrument can process in X and Y as well as the total number of measuring points X·Y
	Objective-specific features	Measuring area	Maximum area that can be detected with a single measurement as well as its extension in X and Y direction
		Working distance	Distance between measuring area or measuring point and the front optics
		Vertical measuring range	Height measuring range detectable within a single measurement
		Objective magnification	Nominal lateral imaging scale of an objective
		Numerical aperture	Aperture angle of the objective towards the object. A high numerical aperture usually means a high imaging quality
		Calculated maximum angle	The maximum angle limited by the aperture angle that could theoretically be measured on mirror-like reflecting surfaces (not applicable to every measuring method)
		Measuring point spacing	Sampling interval of measuring points in the measuring volume, both in X and in Y direction
	Extended measuring range	Calculated lateral optical resolution	Minimum theoretical distance between two adjacent, barely distinguishable features of an object, calculated from the numerical aperture
		Extended measuring area	Maximum size of lateral measuring range that can be detected by stitching multiple single measurements when using the maximum number of measuring points in the measuring area
		Extended measuring area with data reduction	Maximum size of lateral measuring range that can be detected by stitching multiple single measurements, each with a respectively reduced number of measuring points
	Performance features	Extended vertical measuring range	Maximum height range that can be detected by stitching multiple single measurements at a single lateral position
		Measurement noise	Temporal noise of height values, determined during normal usage at ideal ambient conditions
	Dimensions and ambient conditions	Vertical resolution	Smallest distinguishable step height calculated from the measurement noise, with a 95% probability of being detected
		Dimensions	Dimensions of the instrument and accessories. Used to plan the space in which the equipment will be set up. Specified in the three dimensions in space: width, depth and height
		Mass	Total mass of equipment, including all components needed for operation
		Ambient temperature range	Permitted range of ambient temperature during measurement in which the specifications in the data sheet are met
		Permitted temperature gradient	Maximum rate of temperature change during measurement
Permitted relative humidity		Permitted range of relative humidity (non-condensing)	
Supply voltage and type of current		Permitted voltage and frequency range of power supply voltage	
Other features	Electrical power	Maximum electrical power consumption	
	Measuring principle	Name of fundamental physical phenomenon	
Applicationspecific features	Export formats	Data formats to which the topography data can be exported	
	Flatness deviation	Deviation of the measured topography of ideal optical flat from a plane for the single measuring area	
	Maximum deviation of a step height measurement	Greatest deviation of step heights in the total vertical measuring range obtained by multiple measurements	

The complete definition of all terms can be found in the document „Definition of a Comparable Data Sheet for Optical Surface Measurement Devices,“ version 1.2.1 dated 19.04.2016, issued by the Fair Data Sheet Initiative. Free download: <http://optasyst.de/fairedatenblatt/>

MarSurf CM - OPTICAL 3D MICROSCOPY

TECHNICAL SPECIFICATIONS

Measuring head		<i>explorer</i>	<i>expert</i>	<i>select</i>	<i>mobile</i>	
Image acquisition module	Maximum number of measuring points in a single measurement x · y	1200 × 1200 = 1.44 Mio.	1200 × 1200 = 1.44 Mio.	1200 × 1200 = 1.44 Mio.	1200 × 1200 = 1.44 Mio.	
	Max. image rate at full resolution (Hz) ¹	25/(100)	25/(100)	100/(25)	25/100	
	HDR function (16 Bit)	standard	standard	standard	standard	
	Color image acquisition	optional	optional	optional	optional	
Maximum number of measuring points ² (Mio.)		1213	1213	1213	1213	
Vertical measuring module	Motorized positioning unit	Linear encoder	standard	standard	optional	–
		Vertical range (mm)	10	10	10	–
	Fine positioning module (Piezo module)	Vertical range (µm)	350	350	350	350
Collision detection x,y,z		standard	standard	optional	–	
Objective lens holder	Nosepiece 4-way	standard	standard	optional	standard	
	Without nosepiece	–	optional	standard	optional	

1) On request 2) Maximum total number of measuring points that can be acquired in a stitched measurement.

Configuration		<i>explorer</i>	<i>expert</i>	<i>select</i>	<i>mobile</i>
L-stand		L	L	Portal	Mobile
Mass (kg)		25	48	300	8.3
Positioning volume	x · y · z (mm)	50 × 50 × 70	100 × 100 × 70 ¹	200 × 200 × 100 300 × 300 × 100	50 × 50 × 35
Linear encoder x,y		standard	standard	optional	standard
System controller		integrated	integrated	Roll cabinet	integrated
Passive vibration damping		integrated	integrated	standard	optional
Active vibration damping		optional	optional	optional	optional

1) Expandable to 150mm using integrated manual z-axis

Software package		<i>explorer</i>	<i>expert</i>	<i>select</i>	<i>mobile</i>
MarSurf MSW	MarSurf OP MSW HD-Stitching	standard	standard	standard	standard
MarSurf ASW		–	optional	optional	–
MarSurf MfM		optional	optional	optional	optional
Export formats		FITS, NMS, OMS, X3P, ASCII, SDF, TIF, BMP, SUR, STL			
Language packages Mahr Metrology SW		German, English, French, Italian, Spanish, Portuguese, Polish, Russian, Turkish, Japanese, Korean, Chinese			

As of: 20. January 2020. All rights reserved. Subject to modifications, technical improvement and errors excepted.



Objectives

		3200S	1600S	800L	800S	800XS	320L	320S	320XS ¹	160L	160S	160XS ¹
Objective magnification		5x	10x	20x	20x	20x	50x	50x	50x	100x	100x	100x
Measuring area x,y (µm)		3200	1600	800	800	800	320	320	320	160	160	160
Measuring area x × y (mm ²)		10.24	2.56	0.64	0.64	0.64	0.1024	0.1024	0.1024	0.0256	0.0256	0.0256
Extended measuring area (stitching without data reduction) ²	x,y (mm)	92.8	46.4	23.2	23.2	23.2	9.2	9.2	9.2	4.6	4.6	4.6
	x · y (mm ²)	8611	2152	538	538	538	84.6	84.6	84.6	21.1	21.1	21.1
Numerical aperture NA		0.15	0.3	0.4	0.45	0.6	0.5	0.8	0.95	0.8	0.9	0.95
Working distance (mm)		20	11	12	3.1	1	10.6	1	0.35	3.4	1	0.35
Calculated maximum angle (°) ³		8.6	17.5	23.6	26.7	36.9	30.0	53.1	71.8	53.1	64.2	71.8
Vertical measuring range (mm)	Motorized positioning unit	19.9	10.9	11.9	3	0.9	10.5	0.9	0.25	3.3	0.9	0.25
	Fine positioning unit	0.35	0.35	0.35	0.35	0.35	0.35	0.35	0.34	0.35	0.35	0.34
Measurement noise (nm)	Motorized positioning unit	354	71	25	25	14	14	14	14	14	14	14
	Fine positioning unit	–	14	4	4	3	3	1	1	1	1	1
Vertical resolution (nm)	Motorized positioning unit	1000	200	70	70	40	40	40	40	40	40	40
	Fine positioning unit	–	40	12	10	8	8	4	4	4	2	2
Measuring point spacing (µm)	1200x1200 Pixel	2.67	1.33	0.67	0.67	0.67	0.27	0.27	0.27	0.13	0.13	0.13
Calculated lateral optical resolution ⁴ (µm)		1.93	0.96	0.72	0.64	0.48	0.58	0.36	0.30	0.36	0.32	0.30

1) not with MarSurf CM mobile

2) by the example of the image acquisition module 1200x1200 with full resolution

3) the aperture angle that could theoretically be measured on mirror-like reflecting surfaces, on real surfaces higher calculated maximum angle may arise due to diffuse reflections

4) by the example of 475nm light source, calculated according to Rayleigh criterion

Accuracy^{1,2}

		Standard	Uncertainty, standard deviation
Measurement uncertainty by the example of step height measurement ^{2,3,4,5,6}	with objective lens 800 XS	Step = 75 µm	U = 0.320 µm, σ = 0.050 µm
		Step = 10 µm	U = 0.060 µm, σ = 0.020 µm
		Step = 1 µm	U = 0.030 µm, σ = 0.004 µm
Measurement uncertainty by the example of roughness measurement ^{2,3,4,5}	with objective lens 800 XS	Ra = 1.63 µm	U = 0.040 µm, σ = 0.004 µm
		Ra = 0.58 µm	U = 0.024 µm, σ = 0.0066 µm
		Ra = 0.23 µm	U = 0.010 µm, σ = 0.0050 µm
	with objective lens 320 S	Ra = 0.079 µm	U = 0.010 µm, σ = 0.0022 µm
	with objective lens 160 XS	Ra = 0.079 µm	U = 0.003 µm, σ = 0.0004 µm

L: long working distance
S: normal working distance
XS: short working distance

- 1) VIM 2012
- 2) with image acquisition module 1200x1200 with fine positioning unit
- 3) U according to ISO/IEC GUIDE 98-3:2008(E), GUM:1995, K=1.96 (level of confidence 95%)
- 4) σ determined with 25 measurements
- 5) Measured in best possible conditions using PTB certified standards. Results only apply for the standards used.
- 6) Evaluation according to ISO 4287

Sample characteristics

	explorer	expert	select	mobile
Sample height (mm)	70 / (optional 110)	160 / (optional 180)	on request	flexible
Sample weight max. (kg)	10	10	15 / on request	flexible
Sample surface	Reflectivity: 0.1-100%, coated, uncoated, highly reflective to diffuse			

General information

Measuring principle	Patented CMP technology (Confocal Multi Pinhole)
Light source	High performance LED (505/475 nm), MTBF: 50,000 hours (color camera with high performance white light LED)
Typical measuring time (s)	2-8
Dimensions	See technical drawings on the following pages

MarSurf CM select

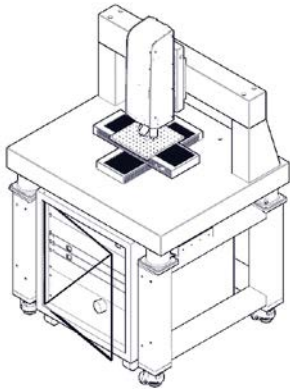

900 × 750 × 1614 (Portal)

3 Axis system x/y/z

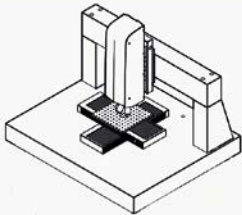

200 × 200 × 100
300 × 300 × 100
(others upon request)

4 Vibration dampers

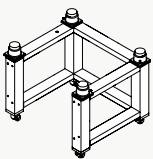

Passive

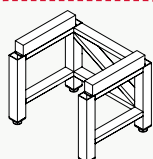

active or vibration
damping system
(optional)

5 Roll container

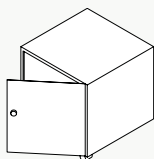

600 × 550 × 660

Dimensions in mm, L × W × H

1 Camera module

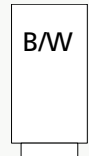

1.4 MP



1.4 MP
(optional)

2 Measuring head

Vertical measuring module

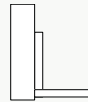

Fine positioning module



Collision detection (optional)

Nosepiece

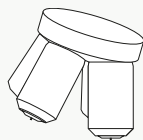

With nosepiece
(optional)

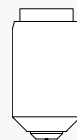

Without
nosepiece

Multi-sensors



Overview
camera (optional)
external bright field /
dark field illumination
(optional)



CP
(optional)

Multi-sensors	Overview camera	Color off axis camera					
		Field of view (mm)	up to 10x10				
		External bright field/dark field illumination	optional				
	Chromatic sensors CP (others upon request)	Type	CP 0.6	CP 1	CP 3	CP 6	CP 10
		Measurement range (mm)	0.6	1	3	6	10
		Working distance (mm)	6.5	19.1	22.5	35	70
		Measurement spot diameter (µm)	4	3.5	12	16	24
		Lateral resolution (µm)	2	1.8	6	8	12
		Vertical resolution (nm)	20	35	100	200	300
		Vertical resolution ¹ (nm)	6	10	30	60	100
Numerical aperture	0.5	0.7	0.5	0.43	0.33		
Thickness measurement range ² up to (mm)	0.9	1.5	4.5	9	15		
Energy supply	Voltage: 100-240 V; Frequency: 50-60 Hz; Power consumption: approx. 550 W						
Computer type	Industrial PC						

1) Reduced measuring range

2) Refraction index n=1.5

MarSurf CM explorer

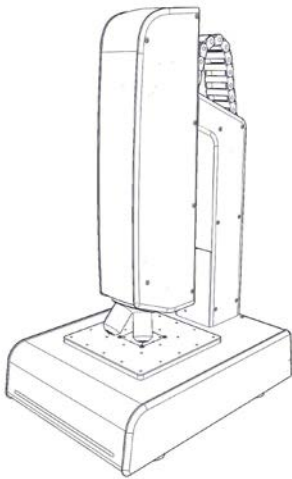

383 × 290 × 690

Electrical power	Voltage: 100-240 V; Frequency: 50-60 Hz Power consumption: approx. 90 W
Computer type	Industrial PC

1 Camera module

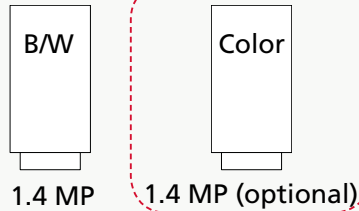

Optional supplemental modules

Active vibration damping

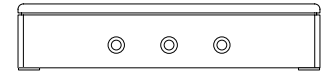

2 Measuring head

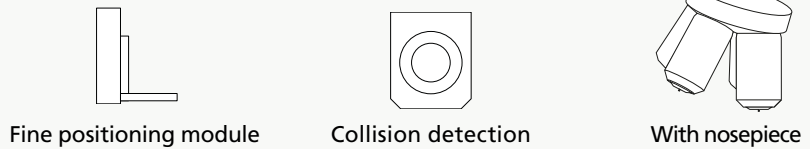

3 Axis system x/y/z

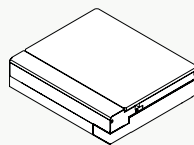

50 × 50 × 70

Dimensions in mm, (L x W x H)

MarSurf CM expert

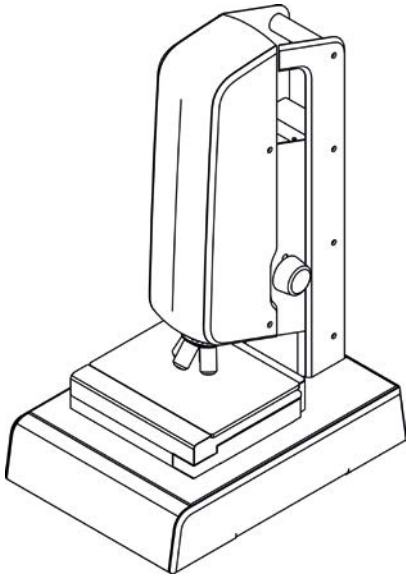

526 × 378 × 799

Electrical power	Voltage: 100-240 V; Frequency: 50-60 Hz Power consumption: approx. 90 W
Computer type	Industrial PC

1 Camera module

B/W

1.4

Color

1.4 MP
(optional)

Optional supplemental modules

Active vibration damping

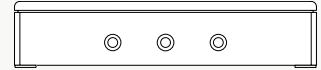

2 Measuring head

Vertical measuring module

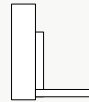

Fine positioning module



Collision detection

Nosepiece

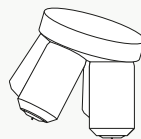

With nosepiece

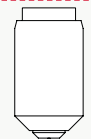

Without nosepiece
(optional)

3 Axis system x/y/z

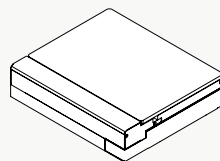

100 × 100 × 70

Dimensions in mm, (LxWxH)

MarSurf CM *mobile*

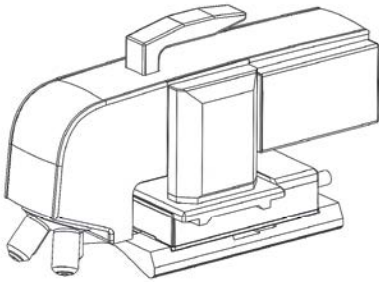

415 x 156 x 234

Electrical power	Voltage: 100-240 V; Frequency: 50-60 Hz Power consumption: approx. 50 W
Computer type	Industrial PC
Cable length	Measurement system: 6 m

1 Camera module

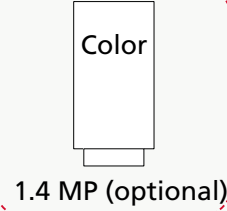
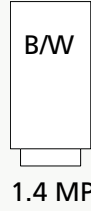

2 Measuring head

With fine positioning module

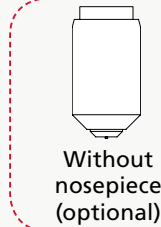
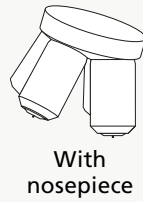

3 Axis system x/y/z

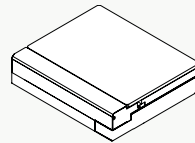

50 x 50 x 35

Optional supplemental modules

Stationary work station

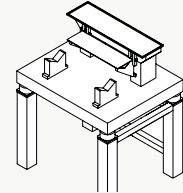

900 x 750 x 1119

Active vibration damping

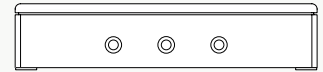

ACCESSORIES

Laboratory table

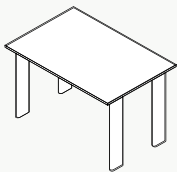

Roughness standard



Depth setting standard

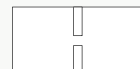

Lateral standard

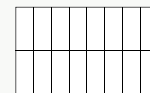

Flatness standard

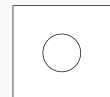

Vacuum chucks

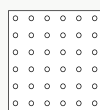

Hole perforated
chuck



Wafer chuck

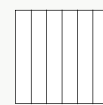

Customized
solution

MarSurf CM - OPTICAL 3D MICROSCOPY

MarSurf MSW

General information	
Languages	English, German, French, Italian, Spanish, Portuguese, Polish, Japanese, Chinese, Korean, Russian, Turkish, Arabic, others to come
Ergonomics	The user interface has a clear structure and it is easy to start a measurement in just a few steps.
Navigator	With the Navigator-function, a rapid overview of the sample surface can be created in which the desired measurement range can easily be selected with the mouse.
3D preview	Fast assessment of topography recorded using a powerful 3D view. Profile cross sections can be used for a quick initial analysis.

Measurement	
Automatic setting of measuring range	Comfortable function for setting the height measurement range quickly and automatically by the software.
Stitching	Generation of large area measurements through combination of single measurements, similar to a panorama image, without reducing the measuring point density.
Shape tracing	Stitching of measurements with intelligent shape tracing and automatic measuring range tracking in order to reduce overall measuring time.
Display of remaining time	Even before the measurement starts, you can approximate measurement time.
Template function	Storage of the measurement currently carried out as a template in order to access the measurement settings again quickly for similar measurements.
Virtual 0/0 position	Setting of 0/0 positions in order to measure distances already in live image mode.
Multi-sensor technology	Switching between the different integrated sensors is no problem. The positioning system moves back to the same sample position after switching.
Bidirectional measuring	Recording of topography by scanning in a back-and-forth movement. This accelerates measurement speeds by a factor up to 2. (only when using CP sensors)

MarSurf ASW

General information	
Languages	English, German, other languages upon request
Operation	Program supports the separation of measurement and analysis units (program is network-capable)
User levels	Multiple security levels with different permissions: administrator, process level, operator
Creating measurement recipe	Intuitive input form for measurement position (joystick support) and sensor settings
Data storage	Storage of measurement data/analysis results in an SQL database

Measurement	
Measurement settings	Sensor settings variable within a measurement run.
Measurement recipe	Automatic approach and measurement at different positions.
Series measurement	Comparison of position using reference points.
Exporting results	ASCII export for integration into QA database, transmission to MarSurf Analysis software, Excel (csv).
Number of measurements per job	unlimited

Analysis	
Results display	Custom-designed analysis protocol, SPC diagram
Reporting recipe	Each measurement point can be assigned specific measurement parameters
SPC	Input of warning and specification limits for measurement data evaluation

Evaluation	
Connections	MarSurf MfM and other analysis software

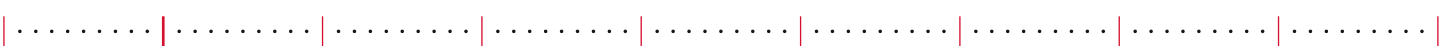

MarSurf MfM

General information	
Languages	English, German, French, Italian, Spanish, Portuguese, Polish, Japanese, Chinese, Korean
Report generation	Automatic report generation, additional information (logos, identification, notes, figures)
Traceability and productivity	Analysis workflow diagram, add, change, or delete analysis steps, minidocs (analysis sequences), any document can be used as a template for the reporting of multiple measurement datasets, OK/NOK criteria can be set for each parameter, results can be exported to .csv format for Excel
Statistics	Multiple populations, control overviews, parameter tables, scatter charts, histograms

Processing	
Intelligent preprocessing	Alignment, form filtering, histogram function, resampling, filling out of unmeasured points, retouching, noise suppression, partition alignment, right-angled, round, or polygonal zoom
Metrological and scientific filters	Gaussian, robust Gaussian and spline filters, FFT, morphological filters, Laplace and Sobel filters, etc.
Segmentation	Segmentation by zoom, threshold calculation and application of binary masks





Evaluation	
International standards	ISO 25178 3D parameters, EUR 15178 EN 3D parameter , definitions for 2D parameters in ISO 4287, ISO 13565 and other standards, ISO 16610 extended filters, ISO 12781 flatness parameters
Functional 3D analysis	Bearing ration curve, graphical study of functional volume parameters in ISO 25178, material and cavity volumes, motif analysis, surface subtraction (wear)
Particle / grain analysis	Grain / particle detection, customized grain characteristics, grain topography, statistics about grains and islands, distribution of peaks, number of peaks
Surface geometry	Distances, angles, areas, volumes, step heights on profiles and surfaces, contour
Contour analysis	Geometric dimensioning of vertical (z-axis) and horizontal (x,y-plane) profiles, analysis of form deviations with automatic generation of a results table
Extended analysis	Fourier spectrum, power spectrum density (PSD), structural isotropy, direction, and periodicity, fractal analysis (box counting method or morphological embedding method)

Presentation	
Analysis of different measurement data types	2D profiles, 3D surfaces, 3D surface with intensity, 3D surface with RGB image, 4D series of 3D surfaces
3D surface display	3D views in real time, images in pseudocolors, photo simulations, contour diagrams, 4D films created from 3D surfaces, simulated flights over surfaces

MarSurf CM - OPTICAL 3D MICROSCOPY

YOUR BENEFITS

Mahr adopts a close orientation towards customer processes in its products, services, and innovation. From consulting to commissioning to ongoing support, we offer you comprehensive service from a single source. Our customers can rely on our well-founded engineering experience and our high quality expectations at any time. Mahr is certified to ISO 9001, OHSAS 18001 und ISO 14001.

Requirements Analysis	Engineering	Commissioning	After-Sales Service
			
Test measurements	Customer-specific adaptations	Installation	Maintenance
Consulting		Training	Repair
Requirement specification	Programming	System relocation	Support
	Integration		Training
			Calibration



Traceability of results and auditability

- Acceptance of all measurement systems in accordance with international standards and PTB-certified standards



Conformity with standards

- Active involvement in international committees for the standardization and norms of optical measurement processes
- Further development of our technology based on the latest standards
- Highest possible standards compliance of measurement results



Environmental consciousness

- Environmentally responsible materials, including supplies and consumables
- Energy-optimized measurement equipment
- Operational environmental management



Qualified customer service

- We offer comprehensive services with short and reliable response times that are individually tailored to the needs of your specific application.
- Continuous and regular maintenance of your measuring system by our trained service staff ensures its precision and durability.
- To ensure continuous smooth operation, we have designed a range of different service packages.

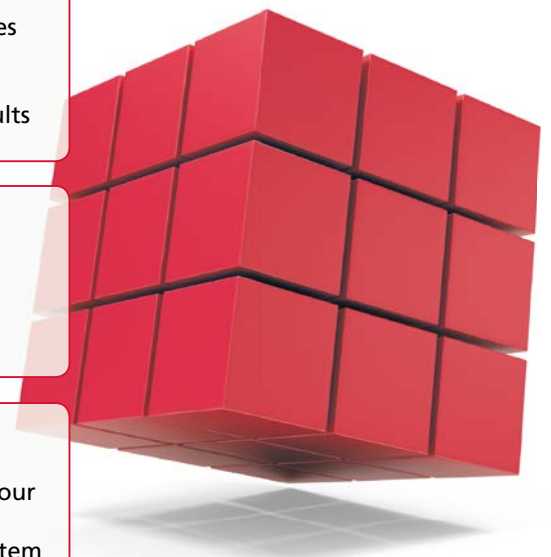

NOTES

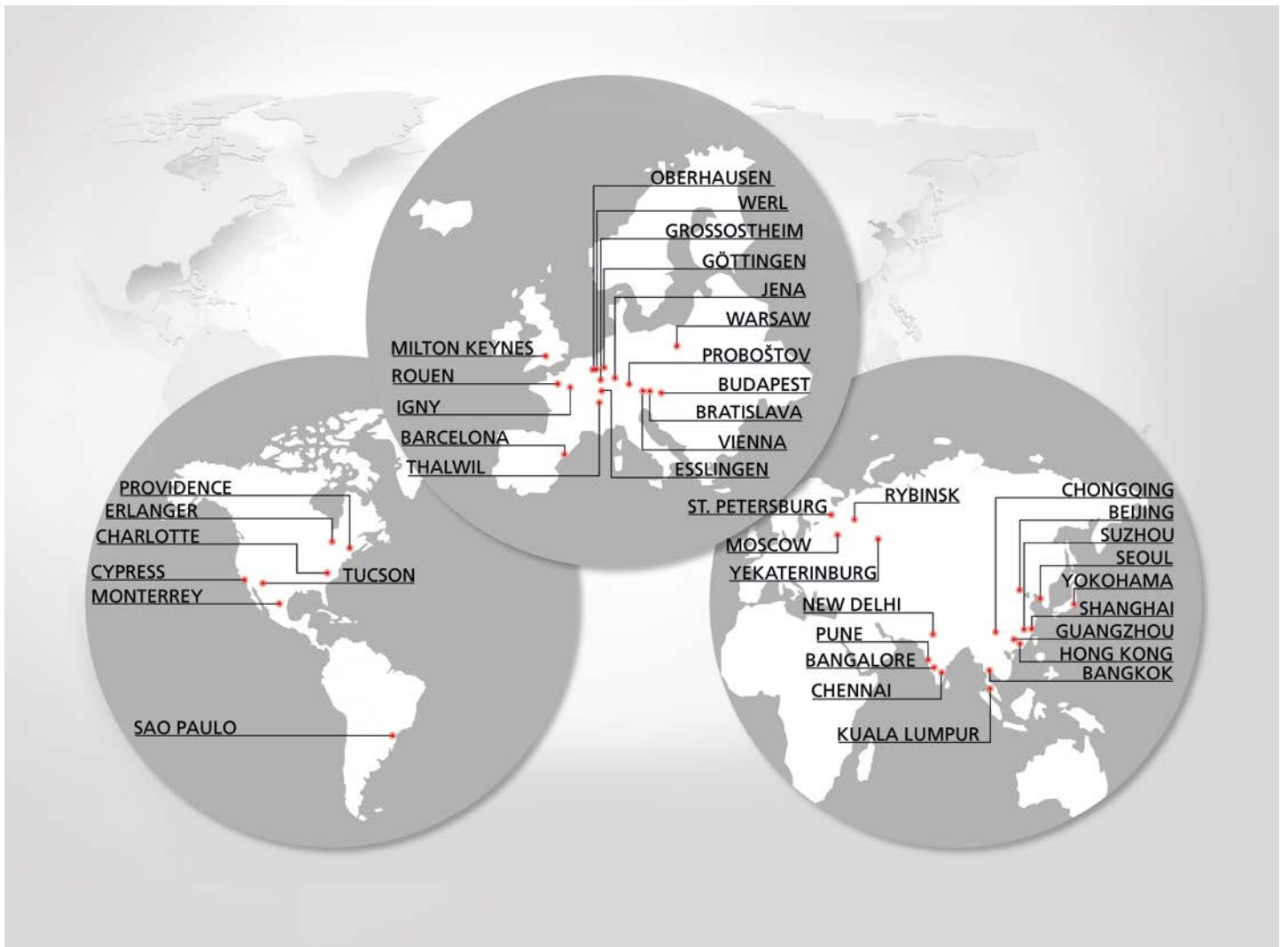

Partner for manufacturing companies worldwide.

Close to our customers.



Mahr GmbH
 Carl-Mahr-Straße 1, 37073 Goettingen, Germany
 Reutlinger Str. 48, 73728 Esslingen, Germany
 Phon +49 551 7073-800, Fax +49 551 7073-888

info@mahr.de, www.mahr.com



© Mahr GmbH

We reserve the right to modify our products, particularly with a view to technical improvement and further development. All illustrations and numbers etc. are therefore subject to change.

3764321 | 02.2020

