

Operating manual

Digimar 817 CLT

Digimar 816 CLT

3722979

0824



Dear customer,

Thank you for choosing a product by Mahr GmbH. We kindly request that you follow the instructions below to ensure the long-term precision of your instrument.

We operate a policy of continuous improvement and are constantly developing our products. Therefore, it is possible that there may be slight differences between the text and illustrations in this document and the instrument in your possession, especially with regard to type designations. We reserve the right to make changes to the design and scope of supply, the right to undertake further technical developments, and all rights relating to translation of this documentation.

© by Mahr GmbH

The following symbols are used in this quick guide:



General information.



Important information. Failure to follow instructions marked with this symbol may cause inaccurate results and damage equipment.



Warning. Risk of injury or death. Must be observed!

Permitted uses

The Digimar 817 CLT / 816 CLT height measuring instrument may only be used to measure lengths, distances, and diameters.

The Digimar 817 CLT / 816 CLT height measuring instrument can be used both close to production and in measuring rooms.

Do not modify the instrument. This may create additional hazards against which the safety mechanisms cannot offer adequate protection.



Any use not in accordance with the "Permitted Uses" or any other use will be considered inappropriate and will result in a voided warranty and the manufacturer's exclusion from liability.

Reasonably foreseeable misuse



Any incidental maintenance work may only be carried out by skilled, trained staff as directed by the operating company.



Work on any parts carrying live voltage must only be carried out once the power supply to the device has been disconnected and any potential residual voltage has been safely discharged.



Safety mechanisms on the device must not be disassembled or bypassed.



Only original probe systems, probe arm units and other accessories produced by the manufacturer may be used.

The *Bluetooth*® brand name is the property of Bluetooth SIG, Inc, which has licensed the use of these brands by Mahr GmbH. Other brand names and trade names are the property of their respective owners.

Disposal



Old electronic equipment which was purchased from Mahr after March 23, 2006 can be returned to us. We will dispose of this equipment in an environmentally-friendly way. The valid EU directives (WEEE, ElektroG) apply.

EU/UK Declaration of Conformity



This measuring instrument complies with the applicable EU/UK directives.

A copy of the current Declaration of Conformity can be downloaded from www.mahr.com/products by selecting the relevant product or can be requested from the following address:
Mahr GmbH, Carl-Mahr-Straße 1, 37073 Göttingen, Germany

We reserve the right to make changes to our products, especially due to technical improvements and further developments. All illustrations, numerical values, etc. are therefore subject to change.

Traceability

We declare, with sole responsibility, that this product conforms with standards and technical data as specified in our sales documents (operating instructions, leaflet, catalog).

We certify that the testing equipment used to check this product, and guaranteed by our Quality Assurance, is traceable to national standards.

Thank you for placing your trust in us by purchasing this product.

Update

The latest version of the software, firmware, and quick guide is available to download on our homepage (Mahr.com/products/). Please note the relevant notes about the version when updating software and firmware.

	Updated	Version
Digimar 817 CLT	05/12/2023	v1.2.08
Digimar 816 CLT	05/12/2023	v1.1.08



Safety instructions

This height measuring instrument complies with the relevant safety regulations. It was dispatched from our production facility in a perfect condition. However, failure to follow the instructions given below can cause personal injury or death:

1. Before you connect up and use the measuring instrument for the first time, please read the accompanying documentation.
2. Only use the instrument in accordance with this quick guide.
Keep the documentation close to the place of use ready for quick reference.
3. This instrument is not designed for operation in explosive environments. An electrical spark could trigger an explosion.
4. Follow safety precautions, accident prevention regulations, and internal company guidelines. You should request further information from your company safety officer.
5. Only the AC adapter provided with the device should be used for charging the internal rechargeable battery or supplying power to the device when used in stationary applications.
6. Before you connect up the equipment, check that the power supply voltage marked on the type plate of the AC adapter matches that of the local mains power supply system. Do not under any circumstances connect the AC adapter if the voltage is not the same!
7. Only use the AC adapter in enclosed areas.
8. The instrument may only be connected to a properly grounded protective contact socket. Any extension cables must meet the stipulations of the VDE (German Association for Electrical, Electronic & Information Technologies).
9. Only Mahr-trained service personnel are permitted to carry out work on this instrument. Protective covers must only be removed by trained technicians and only when servicing is required. Any procedures carried out on this instrument that go beyond those tasks described in the quick guide will void the equipment warranty. Mahr GmbH declines all liability for damage caused by unauthorized procedures.

10. Do not use cleaning agents that contain harmful substances. Do not use solvents. Do not allow any fluids to penetrate the instrument.
11. Inspect the connecting cables for damage. Change damaged cables immediately (Mahr service personnel).
12. Never move the height measuring instrument forcefully at the edge of the measuring plate. The air cushion at the edge does not dissipate quickly enough to slow down the movement of the height measuring instrument. It could fall off the plate and injure the user.
13. The height measuring instrument must only be transported in its original packaging. Otherwise the warranty will be void.

Table of contents

Permitted uses	1	4.6 Zero point offset.....	21
Reasonably foreseeable misuse	1	4.7 Measuring methods.....	22
Safety instructions	3	4.7.1 Basic measuring functions....	22
1 General information	6	4.7.2 2D mode	22
1.1 Scope of delivery.....	6	4.7.3 Quick mode.....	23
1.2 Assembly and setup	7	4.7.4 Measuring program mode	24
2 Elements of the measuring instrument	10	4.7.5 Measuring results	24
2.1 On/off switch	10	5 Annex	25
2.2 Control panel.....	10	5.1 Maintenance and care	25
2.3 Measuring slide.....	11	5.2 Cleaning the instrument	25
2.4 Carrier for measuring anvils	11	5.3 Charging the battery	25
2.5 Quick measurement function keys ...	11	5.4 Technical data.....	26
2.6 Thumbwheel.....	12	5.4.1 Digimar 817 CLT	26
2.7 Button for air bearing.....	12	5.4.2 Digimar 816 CLT	27
2.8 Ports	13	5.5 Device information.....	28
3 User interface of the Digimar software	14	5.6 Accessories.....	29
3.1 Status bar.....	14	5.6.1 Carriers and holders for measuring anvils	29
3.2 Menu bar.....	14	5.6.2 Measuring anvils	29
3.3 Information area.....	15	5.6.3 Spherical probe	30
3.4 Function key bar.....	15	5.6.4 Spherical anvils	30
4 Commissioning	19	5.6.5 Disc and cylindrical measuring anvils.....	30
4.1 Initial commissioning	19	5.6.6 Conical measuring anvils.....	31
4.1.1 Switching ON	19	5.6.7 Accessories for perpendicularity measurements	31
4.1.2 Basic settings.....	19	5.6.8 Depth probe	31
4.2 Reference point run.....	20	5.6.9 Other accessories	32
4.3 Calibrate the probe	20	6 Alphabetical index	33
4.4 Zero point on the measuring plate....	21		
4.5 Workpiece zero point	21		

1 General information

The Digimar 817 CLT / 816 CLT is an electronic height measuring instrument used for measuring and evaluating lengths, distances, and diameters.

It allows you to safely perform measurements and calculation functions, as well as create measuring programs to automate recurring measuring steps.

The height measuring instrument is operated via a swivel and tilting control panel with touchscreen. The Digimar 817 CLT features fast measurement function keys as well as a thumbwheel, which allows convenient positioning of the measuring slide.

The user interface of the height measuring instrument offers clearly structured menus and large buttons with self-explanatory icons to ensure quick and fluid processes.

The handles on each side and the integrated air bearing ensure that the instrument can be moved precisely and effortlessly on the measuring plate.

The Digimar 817 CLT is available in three sizes 350 mm, 600 mm and 1000 mm. The Digimar 816 CLT is only available in two sizes: 350 mm and 600 mm.

The height measuring instrument enables one-dimensional measurements in a vertical direction and two-dimensional measurements if the workpiece can be tilted 90°.

Measuring data can be backed up both wirelessly and by wired connection using the MarConnect duplex interface.

1.1 Scope of delivery

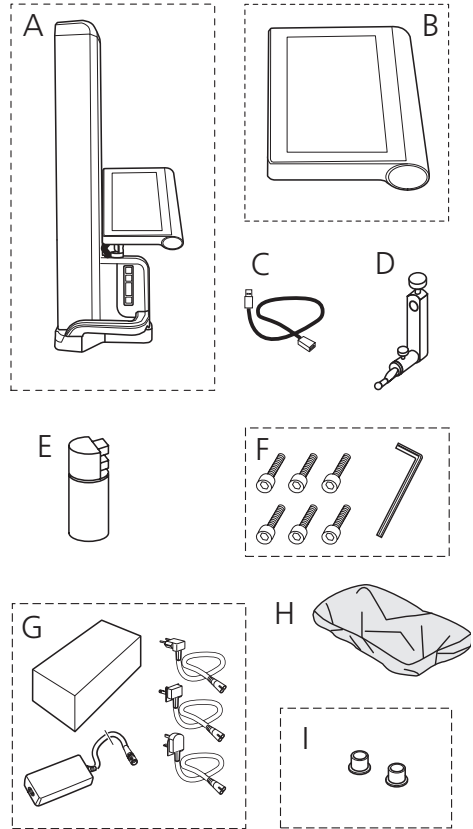

- A Height measuring instrument
- B Control panel with touchscreen
- C Connecting cable for control panel
- D Carrier for measuring anvils
- E Setting normal
- F Cylinder head screws and Allen key
- G AC adapter with plug adapter
- H Protective cover
- I Blind caps

1.2 Assembly and setup

Unpack the control panel

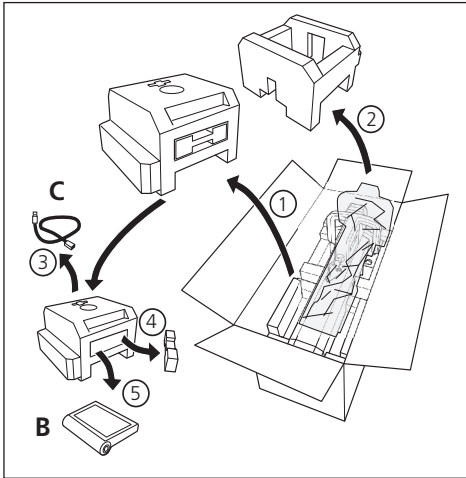

Unpack the columns of the height measuring instrument

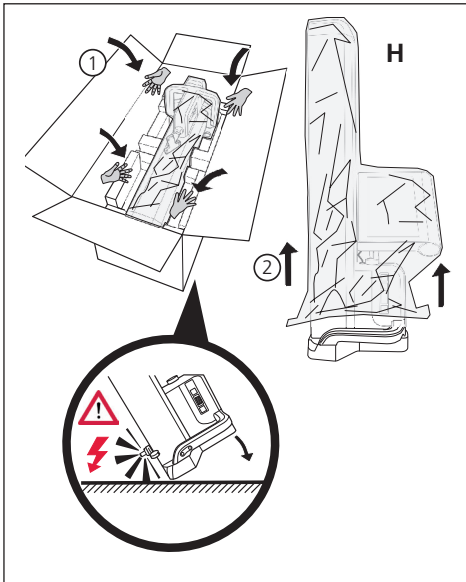

Align the carriers for measuring anvils and undo the measuring slide fixture

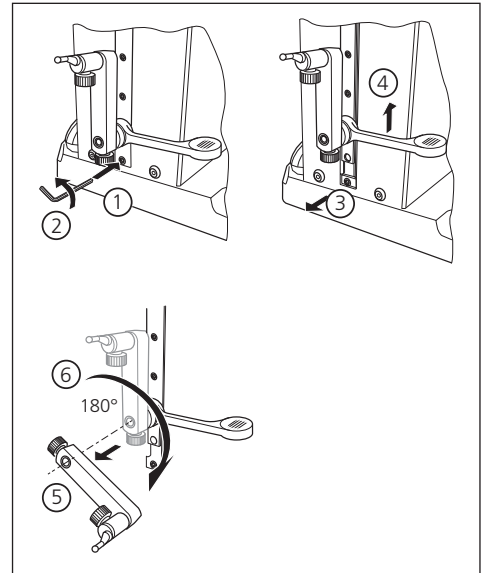

Remove the guard bracket

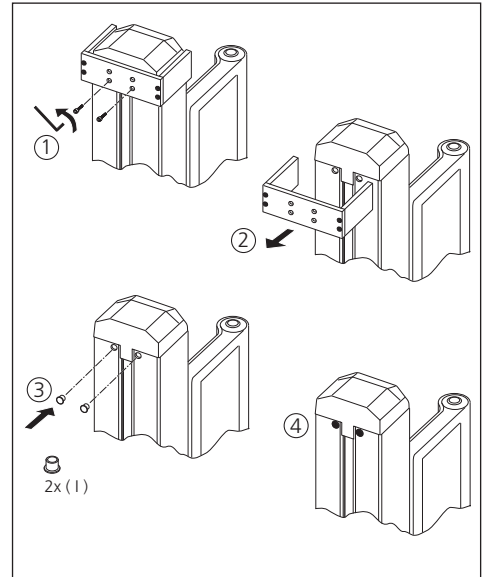

Unpack the AC adapter

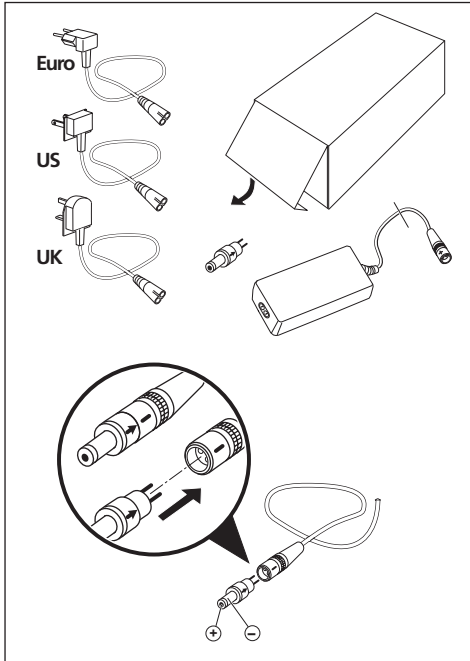

Insert the battery

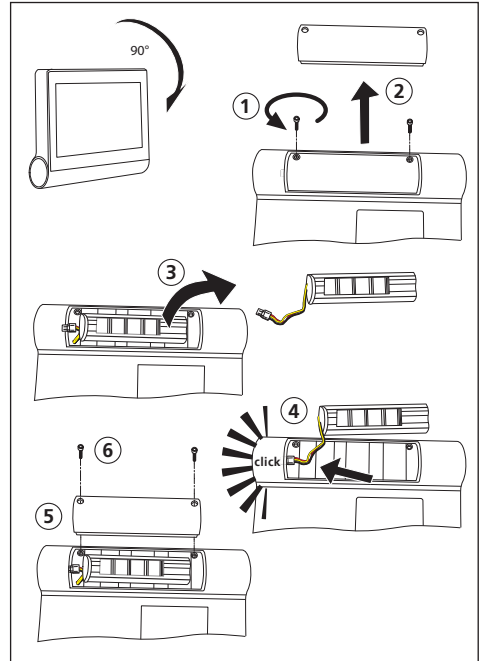

Secure and connect the control panel

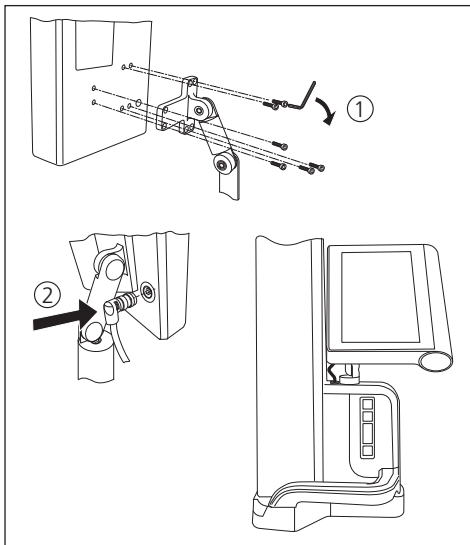

Connect the AC adapter

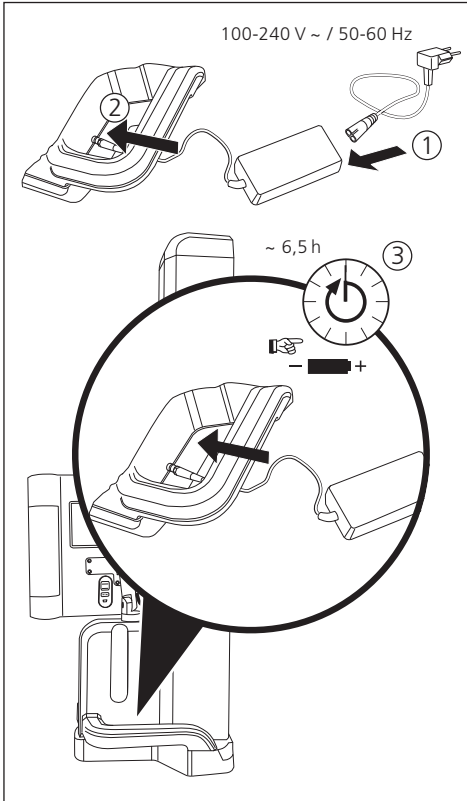

2 Elements of the measuring instrument

The height measuring instruments Digimar 817 CLT and Digimar 816 CLT comprises the following elements:



Fig. 1
Elements of the height measuring instrument
(The image shows the Digimar 817 CLT.)

- 1 Carrier for measuring anvils
- 2 Column of the measuring instrument with measuring slide
- 3 Control panel with on/off switch
- 4 Quick measurement function keys and thumbwheel (only Digimar 817 CLT)
- 5 Ports (back of instrument)
- 6 Handles on both sides (with button for air bearing)

2.1 On/off switch

There is an on/off switch for the height measuring instrument above the control panel.



Fig. 2
On/off switch

2.2 Control panel

The control panel features a swivel and tilt joint on the Digimar 817 CLT and only a tilt joint on the Digimar 816 CLT.

The user interface of the Digimar software is displayed on the touchscreen of the control panel.

2.3 Measuring slide

The measuring slide is in the column of the height measuring instrument and holds the carriers for the measuring anvils.

The measuring slide features a positioning handle, which can be used to manually move the measuring slide in a vertical direction.

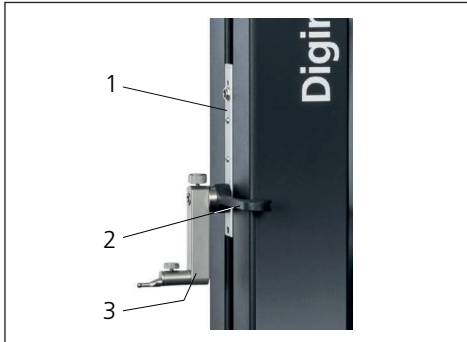

Fig. 3
Measuring slide

- 1 Measuring slide
- 2 Positioning handle
- 3 Standard holder with measuring anvil

The overall height of the column depends on the size of the chosen measuring instrument:

- Height 688 mm (measuring range 350 mm)
- Height 938 mm (measuring range 600 mm)
- Height 1338 mm (measuring range 1000 mm)
(only Digimar 817 CLT)

2.4 Carrier for measuring anvils

The carrier for the measuring anvils can be used to hold different anvils. The instrument comes with standard holder 817 h1 and measuring probe K5/51.

Other carriers and measuring anvils are available as accessories.





2.5 Quick measurement function keys

Only available on the Digimar 817 CLT.

Using the quick measurement function keys on the Digimar 817 CLT, a measurement can be started quickly without having to select it in the user interface of the Digimar software.

The quick measurement keys include a toggle key, which can be used to toggle between "plane" and "bore" measurements.

The quick measurement function keys are located on the base of the height measuring instrument.

-  Starts a measurement in the positive direction by moving the probe up to contact the workpiece from below.
-  Starts a measurement in the negative direction by moving the probe down to contact the workpiece from above.
-  Toggles the measurement type:
 -  "Plane" for a single point measurement
 -  "Bore" measurement for a double point measurement

The status bar of the user interface displays the icon of the active measurement.

2.6 Thumbwheel

The thumbwheel is only available on the Digimar 817 CLT.

The thumbwheel is used to quickly move and position the probe in a positive and negative direction.



*Fig. 4
Thumbwheel*

The travel speed corresponds to how far away the thumbwheel is from its central position, i.e. the further up the thumbwheel is moved, the faster the probe moves in a positive direction.

2.7 Button for air bearing

An air bearing can help you position the height measuring instrument precisely by ensuring that it moves accurately and effortlessly on the measuring plate.

There is a button fitted on the handle of the height measuring instrument to activate the air bearing.



*Fig. 5
Button for activating the air bearing
(The image shows the Digimar 817 CLT.)*

The button and the handles help to move the height measuring instrument properly.



*Fig. 6
Handles for moving the measuring
instrument
(The image shows the Digimar 8127 CLT.)*



Fig. 7
Moving the height measuring instrument using the activated air bearing (The image shows the Digimar 8127 CLT.)

2.8 Ports

The height measuring instrument offers the following connection options:

- Millimess socket on the measuring slide for connecting a dial indicator (Duplex interface for measuring perpendicularity and straightness).
- USB 3.1 sockets (type B)
For connecting:
 - Mahr measuring equipment (1086/16EWR/40EWR/800EW/800EWL)
 - USB memory stick with firmware and software updates, measuring programs, customer logos as well as PDF/Text files
 - USB Bluetooth stick for USB printer
 - I-stick for MarCom software
- Mini USB socket
For connecting wireless measuring value transfer via MarCom software.

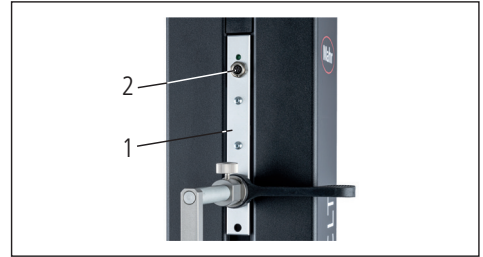

Fig. 8
Millimess port
1 Measuring slide
2 Millimess socket



Fig. 9
USB sockets
1 Mini USB
2 1 x USB 3.1 (black)
3 2 x USB 3.1 (white)
4 8-pin round plug for powering the control panel

3 User interface of the Digimar software

The user interface consists of

- Status bar
- Menu bar
- Information area
- Function key bar



The elements of the user interface are explained in detail in the online help of the Digimar software.

3.1 Status bar

The status bar is on the top edge of the user interface and contains the following elements (from left to right):

- Current date and current time
- Unit of the measuring system
- Activation status of numerical corrections
- Measurement type (plane or bore)
(Only available on the Digimar 817 CLT.)
- Current battery status

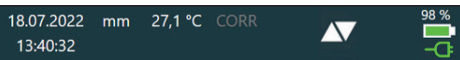

Fig. 10
Status bar of the user interface
of the Digimar 817 CLT

3.2 Menu bar

The menu bar is on the right-hand edge of the user interface and contains the following buttons and display elements:



Opens the "Settings" menu for defining the software settings.



Switches the context-sensitive online help on or off.



Allows you to set zero points.



Allows you to calibrate the probe.



Switches quick mode on or off.
(Only available on the Digimar 817 CLT.)



Indicates that data transfer to a USB memory stick is enabled.



Indicates that data transfer via i-stick using "MarCom Professional" software is enabled.



Indicates that data transfer via mini USB cable using "MarCom Professional" software is enabled.



Indicates that data transfer to a Bluetooth printer is enabled.



Aborts the current action or deletes the highlighted entries from the measuring value list in the information area.



Confirms the current action.



Toggles to other measuring functions to be selected in the function key bar



Toggles to any measuring functions to be selected beforehand in the function key bar.

3.3 Information area

The top part of the information area displays the current measuring value / the current measuring result calculations. The middle section of the information area displays the measuring value list with the results of the measuring functions performed.

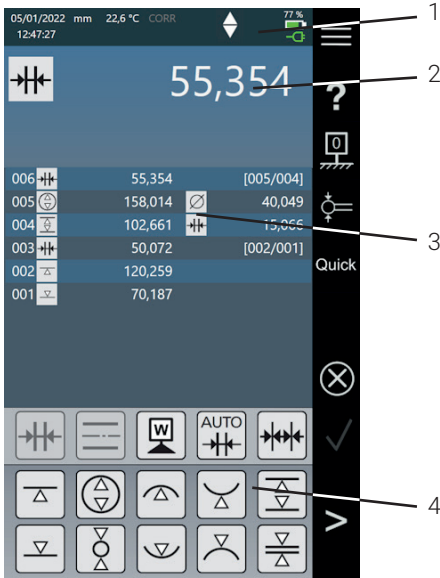

Fig. 11
User interface of the Digimar software
(The image shows the Digimar 8127 CLT.)





- 1 Menu bar
- 2 Current measuring value
- 3 Measuring value list
- 4 Function key bar

When measuring program mode is activated, elements for managing measuring programs and results files are displayed in the information area.





3.4 Function key bar

The function key bar is located below the information area. It contains the buttons for selecting a function. The following buttons are available depending on the mode selected:



















Calibrate the probe

-  Calibrate with groove
-  Calibrate with ledge
-  Calibrate double probe
(Only available on the Digimar 817 CLT.)
-  Calibrate cone probe





Set zero points

-  Base zero point measuring plate
-  Zero point 01 workpiece
-  Zero point 02 workpiece
-  Zero point 03 workpiece
(Only available on the Digimar 817 CLT.)
-  Preset entry

Basic measuring functions









-  Contacting from below
-  Contacting from above
-  Bore
-  Shaft
-  Bore top
-  Bore bottom
-  Shaft bottom
-  Shaft top
-  Groove
-  Ledge
-  Bore center
-  Min-Max
-  Cone measurement *(Only available on the Digimar 817 CLT.)*
-  Perpendicularity measurement
-  Enable 2D mode *(Only available on the Digimar 817 CLT.)*
-  Enable measuring program mode
-  Output measuring results as measuring record file in PDF format
-  Output measuring results as Text file

Calculation functions

-  Distance calculation
-  Symmetry calculation
-  Set zero point workpiece
-  Automatic distance calculation *(Only available on the Digimar 817 CLT.)*
-  Automatic chain measurement

















Other buttons for functions

If other information is possible for any of the functions, the following buttons are displayed in the function key bar depending on the function:







-  Move measuring probe upwards and contact
-  Move measuring probe downwards and contact
-  Stop measurement and calculation of measuring results
-  Pause measurement
-  Set measuring plate as reference for the measuring results
-  Calculate the relative result values for "Min-Max function"
-  Calculate absolute result values for "Min-Max function"
-  Set X-value and Z-value to zero, e.g. in "perpendicularity measurement"

Measuring functions in 2D mode



Measuring in 2D mode is only available on the Digimar 817 CLT.

-  Enter tilting angle manually
-  Calculate tilting angle with dial comparator or dial indicator
-  Tilt workpiece to the right
-  Tilt workpiece to the left
-  Bore
-  Shaft
-  Bore center
-  Show graph
-  Alternative zero point
-  Alternative reference axis
-  Index circle
-  Regression line
-  Angle between two straight lines
-  Intersection point
-  Distance
-  Output measuring results as measuring record file in PDF format
-  Output measuring results as Text file

Manage measuring program

-  Allows you to run the measuring program currently highlighted in the file list
-  Allows you to create a new measuring program
-  Allows you to edit the measuring program currently highlighted in the file list
-  Deletes the measuring program(s) currently highlighted in the file list from an internal memory in the height measuring instrument
-  Copies all of the measuring programs to the connected USB memory stick
-  Copies all of the measuring programs from the connected USB memory stick to the internal memory of the height measuring instrument

Manage results files

-  Deletes the results file(s) currently highlighted in the file list from the internal memory of the height measuring instrument
-  Displays the contents of the results file currently highlighted in the file list
-  Copies all results files to the connected USB memory stick

Edit measuring programs

The buttons below add the relevant function as a measuring step:

 "Contacting from below" measuring function

 "Contacting from above" measuring function

 "Bore" measuring function

 "Shaft" measuring function

 "Bore top" measuring function

 "Bore bottom" measuring function

 "Shaft bottom" measuring function

 "Shaft top" measuring function

 "Groove" measuring function

 "Ledge" measuring function

 "Bore center" measuring function

 Function
"Base zero point measuring plate"

 "Distance calculation" calculation function

 "Symmetry calculation" calculation function

 "Delay" function

 "Set zero point workpiece" calculation function

Running measuring programs

 Starts running the measuring program

 Performs the next measuring step in the measuring program

 Stops the measuring program

 Pauses the measuring program

 Skips to the previous measuring step
(Only available on the Digimar 817 CLT.)

 All of the functions are explained in detail in the online help of the Digimar software.

4 Commissioning

4.1 Initial commissioning

The height measuring instrument must be used on a granite plate of quality class 0 or 1. The measuring plate must stand on vibration-free ground (vibrations from stamping die or the like must not be transmitted).

The height measuring instrument must be correctly assembled and connected before initial commissioning.



The AC adapter must be connected to the charging socket. After approx. 5 minutes the battery is charged enough for the height measuring instrument to be switched on.

4.1.1 Switching ON

- To switch on the height measuring instrument, press the on/off switch above the control panel.
- As soon as the operating system of the height measuring instrument starts up, the user interface of the Digimar software will appear on the control panel.

4.1.2 Basic settings

When starting up for the first time, some parameters such as language and unit of measurement need to be set. To do so:

- Press the  button in the menu bar of the user interface.
- In the "Settings" menu that now appears, press the  button for the "Instrument settings" in the menu.

The "Instrument settings" screen is displayed in the user interface.

- In this screen, set the current date, the time and the language for the Digimar software.
- If applicable, specify a time interval for the height measuring instrument to automatically switch off.
- If applicable, specify a time interval for the display backlight to automatically switch off.
- If applicable, set the brightness for the backlight of the display.
- Activate password protection if necessary.
- Once all of the settings have been defined, repeatedly press the  button in the menu bar of the user interface to apply the entries and close the "Settings" menu.



The settings options are explained in detail in the online help of the Digimar software.

4.2 Reference point run

A reference point run is performed automatically as soon as the height measuring instrument is switched on, whereby the probe is moved in the positive and then in the negative direction. The zero point of the Z-axis is set on the measuring plate during this process.

The zero point can be set anywhere, e.g. on a workpiece surface using the "zero point 01 workpiece" function.

If you want to extend the working area of the height measuring instrument, a surface can be contacted at a certain height and this height can be set as the zero point offset using the "Preset entry" function.

4.3 Calibrate the probe

- Insert the desired measuring anvil in the carrier on the measuring slide and place the setting gage on the measuring plate.
- Press the  button in the menu bar of the user interface.
- Press the button for the desired calibration process in the function key bar.



Calibrate with groove



Calibrate with ledge



Calibrate double probe
(Only available on the Digimar 817 CLT.)



Calibrate cone probe

- Manually position the measuring probe to the relevant height for the calibration process, e.g. to the height of the groove center of the setting gage when the "Calibrate with groove" function is selected.

- Move the setting gage so that the measuring probe is in the groove.



Fig. 12
Positioning the setting gage when calibrating with groove

- The calibration process is performed automatically. An animation of the calibration process is shown in the user interface for the purpose of visual control.
- The calculated probe constant is displayed in the top section of the information area.



The individual calibration processes are explained in detail in the online help of the Digimar software.

4.4 Zero point on the measuring plate

- Press the  button in the menu bar of the user interface.

If other workpiece zero points have already been set, the button of the current zero point will appear in the menu bar. In this case, press this button.

- Press the  button in the function key bar of the user interface.
- The probe automatically moves onto the measuring plate and assumes the contacted position as the zero point.

Any zero points previously set (01, 02 and 03 as well as Preset) are automatically deleted during this process.

4.5 Workpiece zero point

- Contact the surface whose position is to be used as the zero point.
- Press the  button in the menu bar of the user interface.

If other workpiece zero points have already been set, the button of the current zero point will appear in the menu bar. In this case, press this button.

- Press the button for the zero point to be set in the function key bar:



Zero point 01 workpiece



Zero point 02 workpiece



Zero point 03 workpiece
(Only available on the
Digimar 817 CLT.)



- Press the  button in the menu bar to set the workpiece zero point.

4.6 Zero point offset

The measuring range of the height measuring instrument can be extended with a zero point offset. For example, the height 150.00 mm can be assigned to a position of 50.00 mm with a zero point offset of 100.00 mm, i.e. the measuring range shifts by 100 mm.

- Press the  button in the menu bar of the user interface.

If other workpiece zero points have already been set, the button of the current zero point will appear in the menu bar. In this case, press this button.

- Press the  button in the function key bar of the user interface.
- The "PR" input box and a dialog box with numerical keypad are displayed in the information area of the user interface.
- Enter the value of the zero point offset using the numerical keypad and press the  button in the menu bar to accept the entered value.
- The measuring range is extended by the entered value.

4.7 Measuring methods

4.7.1 Basic measuring functions

The basic measuring functions can be started quickly and easily at the push of a button.

The procedure here is always the same:

- Position the measuring probe above/below the point to be measured.
- Press the button of the desired measuring function in the function key bar of the user interface.
- The measuring probe automatically approaches the surface to be measured and accepts the measuring value.

For dynamic measurements where a maximum or minimum (bores or shafts) is to be measured, you need to move either the workpiece or the measuring instrument in such a way that the measuring instrument can calculate an extreme value. In measurements with two consecutive contacting processes (e.g. bore, groove, or shaft), the first contacting process is always performed upwards.







The individual measuring functions are explained in detail in the online help of the Digimar software.

4.7.2 2D mode

Only available on the Digimar 817 CLT.

Common 2D measuring tasks can be completed with the measuring functions in 2D mode, including calculations of index circles (hole circle) or angles and distances between bores. To this end, the measurements of the Z and X axes are each measured and saved separately.

The sequence of measuring functions in 2D mode is always as follows:

- Activate 2D mode by pressing the  button.
- Measure the features in the Z-axis.
- Tilt/rotate the workpiece (usually 90°) by pressing the  or  button.
- Measure the features again in the same order in the X-axis.
- If other features are to be measured in the Z-axis, the workpiece must be tilted back again by pressing the  /  button.
- Perform the calculations, e.g. "index circle".

When 2D mode is activated, the function key bar of the user interface displays the relevant buttons for the possible measuring functions.

The results of the measurements performed can be displayed as a measuring value list or graph in the information area of the user interface.

The graph can be switched on or off by pressing the  button.



The individual measuring functions in 2D mode are explained in detail in the online help of the Digimar software.

4.7.3 Quick mode

Only available on the Digimar 817 CLT.

In quick mode, the system automatically identifies the desired measuring function based on the measuring slide movement and starts it automatically.

Quick mode can be used, for example, to conduct chain measurements or several bores (e.g. in hole circle calculations) quickly and efficiently.

To activate quick mode:

- Press the  button in the menu bar of the user interface.

When quick mode is activated, the lettering on the button is green.

- Press the toggle key  for the type of measurement on the base of the height measuring instrument.
- The status bar displays the icon of the active measurement
 - ▲▼ "Plane" measurement for single point measurement.
 - ◆▼ "Bore" measurement for double point measurement.
- Move the measuring probe to a position at the point to be measured, e.g. above the surface to be contacted.

- Gently move the slide towards the surface to be contacted, e.g. downwards, using the positioning handle.

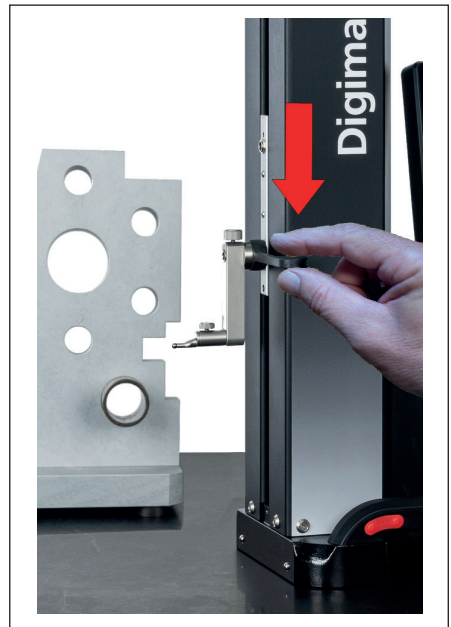



Fig. 13
Move the slide down using the positioning handle

- The instrument recognizes that the surface is to be contacted and starts the measuring function automatically.
- After contacting, the measured value is accepted and displayed in the top section of the information area.

 A measurement in quick mode can be aborted at any time by pressing the  button in the menu bar of the user interface.

4.7.4 Measuring program mode

Measuring program mode allows you to automate recurring measuring steps by creating, saving (as a file), and then running a measuring program.

The results of a measuring program can be saved and displayed as a results file in PDF and/or Text format.

To activate measuring program mode:

- Press the  button in the menu bar of the user interface, and select "Programs" from the "Settings" menu that now appears.

Or press the  button in the function key bar of the user interface.

- Measuring program mode is enabled and the "Programs" screen appears.

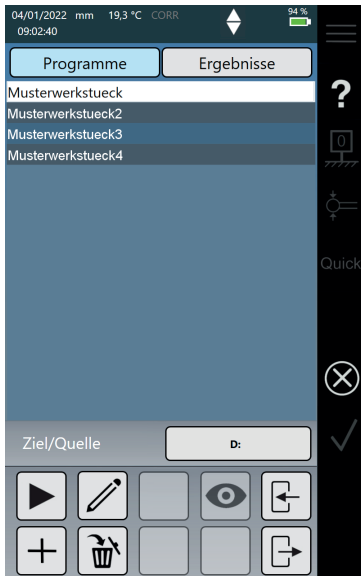

Fig. 14
"Programs" screen
(The image shows the Digimar 8127 CLT.)

- In the "Programs" screen, you can select and manage measuring programs as well as the results files of measuring programs that have run.

When measuring program mode is activated, the function key bar of the user interface displays the relevant buttons for managing measuring program and results files and for editing measuring programs.



The online help of the Digimar software explains in detail how to create, edit, and run a measuring program.

4.7.5 Measuring results

Measuring results can be saved in PDF and/or Text files.



The online help of the Digimar software explains in detail how to create and output PDF and Text files.

5 Annex

5.1 Maintenance and care

Make sure that the measuring plate is always kept clean. Dust, oil and coolant emissions must be removed from the measuring plate every day.

Dirt on the air bearings has a detrimental effect on measuring behavior and accuracy.

The battery can be changed without the data stored in the instrument being lost.

5.2 Cleaning the instrument

The instrument can be cleaned using a damp cloth. When cleaning, do not allow any liquids to penetrate the instrument!

Do not use solvents or detergents that are corrosive or harmful to plastics for cleaning.

The air bearings can be cleaned with methylated spirits (alcohol).

5.3 Charging the battery

To charge the battery, the AC adapter must be connected to the charging socket. The charge status of the battery is displayed in the status bar of the user interface ().

The AC adapter can also be permanently connected, as an overload fuse monitors the charging process. The battery continues to charge when the height measuring instrument is switched off ().

A disconnected battery will also be displayed in the status bar (.



Batteries discharge over time even when they are not in use. Discharged batteries can lose their capacity or become completely unusable. The battery should therefore be charged every 6 months.



Never short-circuit the battery. There is a risk of fire and explosion!



The height measuring instrument should always be operated with the battery inserted.

5.4 Technical data

5.4.1 Digimar 817 CLT

	ML350	ML600	ML1000
Measuring range	0 - 350 mm	0 - 600 mm	0 - 1000 mm
Item no.	4429600	4429601	4429602
Measuring range extension		170 mm	
Resolution	0.01 / 0.005 / 0.001 / 0.0005 / 0.0001 mm		
Error limit (μm)	(1.8 + L/600) L in mm		
Repeatability: plane ($\pm 2\sigma$)	0.5 μm		
Repeatability: bore ($\pm 2\sigma$)	1 μm		
Perpendicularity deviation	5 μm	6 μm	10 μm
Measuring force	1.0 +/-0.3 N		
Measuring speeds	5 / 8 / 11 / 15 / 20 mm/s		
Maximum positioning speed			
- manual	1000 mm/s		
- motorized thumbwheel	80 mm/s		
Drive	motorized		
Compressed air supply	built-in compressor		
Vertical measuring system of the column	incremental measuring system		
Resolution of vertical measuring system	0.1 μm		
Working temperature	20°C		
Operating temperature**	10 °C to 40°C		
Storage temperature	-10 °C to 60°C		
Permitted relative humidity	max. 65 % (non-condensing)		
Temperature sensor error limit	+/-0.25°C		
Power supply	12 VDC / 3.8 A / Type FW7405M/12		
Supply voltage / mains frequency	110 - 230 V AC / 50 - 60 Hz		
Operating time, maximum	14 h		
Battery voltage	7.2 V		
Battery capacity	11500 mAh		
Rechargeable battery type	Lithium-ion battery		
Protection rating	IP40		

5.4.2 Digimar 816 CLT

	ML350	ML600
Measuring range	0 - 350 mm	0 - 600 mm
Item no.	4429630	4429631
Measuring range extension		170 mm
Resolution	0.01 / 0.005 / 0.001 / 0.0005 / 0.0001 mm	
Error limit (μm)	(2.0 + L/400) L in mm	
Repeatability: plane ($\pm 2\sigma$)	1 μm	
Repeatability: bore ($\pm 2\sigma$)	2 μm	
Perpendicularity deviation	5 μm	8 μm
Measuring force	1.0 +/-0.3 N	
Measuring speeds	5 / 8 / 11 / 15 / 20 mm/s	
Maximum positioning speed		
- manual	1000 mm/s	
- motorized thumbwheel	80 mm/s	
Drive	motorized	
Compressed air supply	built-in compressor	
Vertical measuring system of the column	incremental measuring system	
Resolution of vertical measuring system	0.1 μm	
Working temperature	20°C	
Operating temperature**	10 °C to 40°C	
Storage temperature	-10 °C to 60°C	
Permitted relative humidity	max. 65 % (non-condensing)	
Temperature sensor error limit	+/-0.25°C	
Power supply	12 VDC / 3.8 A / Type FW7405M/12	
Supply voltage / mains frequency	110 - 230 V AC / 50 - 60 Hz	
Operating time, maximum	14 h	
Battery voltage	7.2 V	
Battery capacity	11500 mAh	
Rechargeable battery type	Lithium-ion battery	
Protection rating	IP40	

5.5 Device information

	ML350	ML600	ML1000
Item no.	4429600 4429630	4429601 4429631	4429602
Weight	22.2 kg	25.6 kg	28.6 kg
Dimensions (D x W x H) in mm	255 x 278 x 688	255 x 278 x 938	255 x 278 x 1338

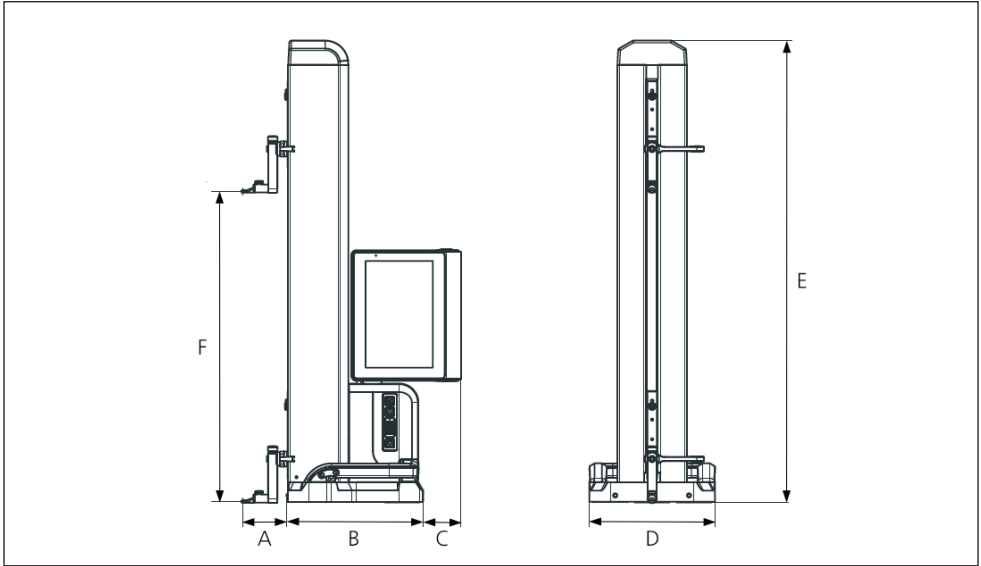

Fig. 15
Instrument dimensions

- A 89.2 mm
- B 278 mm
- C 77 mm
- D 255 mm
- E 688 mm | 938 mm | 1338 mm
- F 0 - 350 mm | 0 - 600 mm | 0 - 1000 mm

5.6 Accessories

5.6.1 Carriers and holders for measuring anvils

Order no.	Description	Type	Holder	Application
4429154	Carrier	817 h1	ø 6 mm	universal
4429219	Carrier	817 h2	ø 6 mm	for large measuring depths
4429220	Carrier	817 h4	ø 8 mm	universal
4429454	Carrier with pivoting holder	817 h5	ø 6 mm	combined with the cylinder keys
3015917	Probe holder	Gk/8	M3 / ø 4 mm	for delicate workpieces
4429256	Probe holder incl. measuring anvil ø 2.0 mm	KM 2	M2	for delicate workpieces

5.6.2 Measuring anvils

Order no.	Description	Type	Holder	Suitable for
4305870	Measuring anvil ø 1.0 mm, carbide, l = 14.5 mm	800 ts	M2	KM 2, TMT 120, TMT 120 S
4305850	Measuring anvil ø 2.0 mm, carbide, l = 14.5 mm	800 ts	M2	KM 2, TMT 120, TMT 120 S
4305871	Measuring anvil ø 3.0 mm, carbide, l = 14.5 mm	800 ts	M2	KM 2, TMT 120, TMT 120 S
4309051	Measuring anvil ø 2.0 mm, ruby, l = 14.5 mm	800 tsr	M2	KM 2, TMT 120, TMT 120 S

5.6.3 Spherical probe

Order no.	Description	Type	Holder	Suitable for
3022002	Spherical probe, dk = 1.0 mm l = 24 mm, carbide	K1/24	M3	Holder Gk/8
3022001	Spherical probe, dk = 2.0 mm, l = 24 mm, carbide	K2/24	M3	Holder Gk/8
3022000	Spherical probe, dk = 3.0 mm, l = 24 mm, carbide	K3/24	M3	Holder Gk/8

5.6.4 Spherical anvils

Order no.	Description	Type	Holder	Suitable for
4429158	Spherical anvil, ø 5.0 mm, carbide	K5/51	ø 6 mm	Carrier 817h1/-h2/-h5
4429254	Spherical anvil, ø 6.0 mm, carbide	K6/31	ø 6 mm	Carrier 817h1/-h2/-h5
7023813	Spherical anvil, ø 4.0 mm, carbide	K4/30	ø 8 mm	Carrier 817 h4
7023816	Spherical anvil, ø 6.0 mm, carbide	K6/40	ø 8 mm	Carrier 817 h4
7023810	Spherical anvil, ø 10.0 mm, carbide	K10/60	ø 8 mm	Carrier 817 h4
7023815	Spherical anvil, ø 10.0 mm, carbide	K10/100	ø 8 mm	Carrier 817 h4

5.6.5 Disc and cylindrical measuring anvils

Order no.	Description	Type	Holder	Suitable for
4429226	Disc measuring anvil ø 15 mm	S15/31.2	ø 6 mm	Carrier 817h1/-h2
4429227	Cylinder measuring anvil ø 10 mm	Z10/31.2	ø 6 mm	Carrier 817 h5

5.6.6 Conical measuring anvils

Order no.	Description	Type	Holder	Suitable for
4429228	Conical measuring anvil	MKe 30	∅ 6 mm	Carrier 817h1/-h2
3015920	Conical measuring anvil	MKe 8	M3	Holder Gk/8

5.6.7 Accessories for perpendicularity measurements

Order no.	Description	Type	Holder	Suitable for
4429206	Holder for perpendicularity measurement	817 h3	∅ 8 mm	Dial comparators and dial indicators
4429610	Data connection cable	DK-M1		2000 W / 2001 W
4346700	Digital dial comparator 0.00001 mm / ± 2 mm	2000 W	∅ 8 mm	-
4346800	Digital dial comparator 0.00001 mm / ± 2 mm	2001 W	∅ 8 mm	-
4305120	Digital dial test indicator	800 EW	∅ 8 mm	
4306120	Digital dial test indicator	800 EWL	∅ 8 mm	

5.6.8 Depth probe

Order no.	Description	Type	Holder	Suitable for
4429221	Depth probe	TMT 120	∅ 6 mm	-
4429421	Depth probe, pivotable	TMT 120 S	∅ 6 mm	-
3015918	Probe shoe, d = 0.5 mm, l = 78 mm	TS 0.5/78	∅ 4 mm	Holder Gk/8
3015919	Stylus/stylus tip, d = 1.2 mm, l = 75 mm, ls = 15.5 mm	T 1.2/75	∅ 4 mm	Holder Gk/8
4429256	Probe holder incl. measuring anvil ∅ 2.0 mm	KM 2	M2	Carrier 817h1/h2

5.6.9 Other accessories

Order no.	Description	Type
6910271	Printer set including Bluetooth USB adapter	DP-B1
5450105	Printer paper, 12 rolls	
4102220	USB adapter for MarConnect Wireless	i-stick
4221525	Test plate made of granite, 1,000 x 630 mm	107 G
4221573	Safety frame, 1,000 x 630 mm	107 Ug
4221526	Test plate made of granite, 1,200 x 800 mm	107 G
4221574	Safety frame, 1,200 x 800 mm	107 Ug
7034001	Demo workpiece	

6 Alphabetical index

Symbols		G	
2D mode	17, 22	General information	6
		Granite plate	19
		Graph	22
A		I	
Abort action	14	Information area of the user interface	15, 22
Accessories	29	Initial commissioning	19
Activate air bearing	12	Insert the battery	8
Air bearing	12	Instrument settings	19
Assembly and setup	7	I-stick	13
Automatic switch off	19		
B		L	
Basic measuring functions	16, 22	Language	19
Battery status	14		
C		M	
Calculation functions	16	Mahr measuring equipment	13
Calibrate the probe	15, 20	Maintenance and care	25
Calibration process	20	Manage results files	17
Carrier for the measuring anvils	11	Managing measuring programs	17
Chain measurements	23	Measuring functions in 2D mode	17, 22
Charging the battery	25	Measuring program mode	24
Cleaning	25	Measuring result display	15
Commissioning	19	Measuring results	24
Confirm action	14	Measuring slide	11
Connection options	13	Measuring value list	15
Context-sensitive online help	14	Menu bar	14
Control panel	10	Millimess socket	13
		Mini USB socket	13
D		Move probe down	11
Date	14, 19	Move probe up	11
Device information	27		
Double point measurement	11	O	
Dynamic measurements	22	Online help	14
		On/off switch	10
E		Other functions	16
Edit measuring programs	18		
Elements of the measuring instrument	10	P	
Extended working area	20	Password protection	19
Extend measuring range	21	Positioning handle	11, 23
		Position probe quickly	12
F		Probe constant	20
Function key bar	15, 22	"Programs" screen	24
		Q	
		Quick measurement function keys	11
		Quick mode	23

R	
Reference point run	20
Running measuring programs	18

S	
Safety instructions	3
Scope of delivery	6
Settings	19
Set zero points	15
Show data transfer	14
Single point measurement	11
Start measurement	11
Switching on	19
Swivel and tilt joint	10

T	
Technical data	26
Thumbwheel	12
Time	14, 19
Toggle key	11, 23

U	
Unit of measurement	19
Unit of the measuring system	14
USB Bluetooth stick	13
USB memory stick	13
USB sockets	13
User interface	14, 19

W	
Workpiece zero point	21

Z	
Zero point	20
Zero point offset	20, 21
Zero point on the measuring plate	21



www.mahr.com